



A8

Audi A8 | A8 L | A8 L W12
Audi S8

Vorsprung durch Technik **Audi** 



Dialogue: Audi QR codes

Experience Audi even more directly: download a QR app to your smartphone and then scan the QR code or follow the given link in your browser.



Fascination

- 4 Audi A8
18 Audi A8 L W12
- 14 Audi A8 L
24 Audi S8

Technology

- 32 Innovations
42 Intelligent performance
- 34 Audi ultra
44 hybrid
- 36 Audi connect
46 Dynamics
- 38 quattro®
48 Assistance systems
- 40 Audi Matrix LED headlights
50 Simplicity

Equipment

- 54 S model
80 Lights
- 56 Engines
81 Design
- 58 Audi design selection
82 Steering wheels/controls
- 62 Audi exclusive
83 Comfort
- 66 A8 Audi exclusive concept
87 Infotainment
- 68 Paint finishes
90 Assistance systems
- 70 Wheels/tyres
92 Technology/safety
- 72 Seats/headlinings
93 Audi Extended Warranty
- 78 Inlays

Other

- 94 Audi Genuine Accessories
102 Standard/optional equipment
- 96 Technical data
112 The fascination of Audi
- 100 Dimensions

The equipment for the vehicles illustrated in the Fascination section can be found on page 110. The fuel consumption and CO₂ emission figures can be found from page 96 onwards.

Design

The art of progress. Beautifully expressed in visual form. In an exceptional vehicle. The Audi A8. Awe-inspiring and sporty, while staying true to one clear principle: concentration on the essential. Not a single line without a function. Distinctively structured surfaces. Exclusive materials. All finished to a supreme standard. And aspiring to something very special – brilliance down to the last detail.

Brilliant details.
Flawlessly styled and timeless.

The fuel consumption and CO₂ emission figures can be found on page 96.

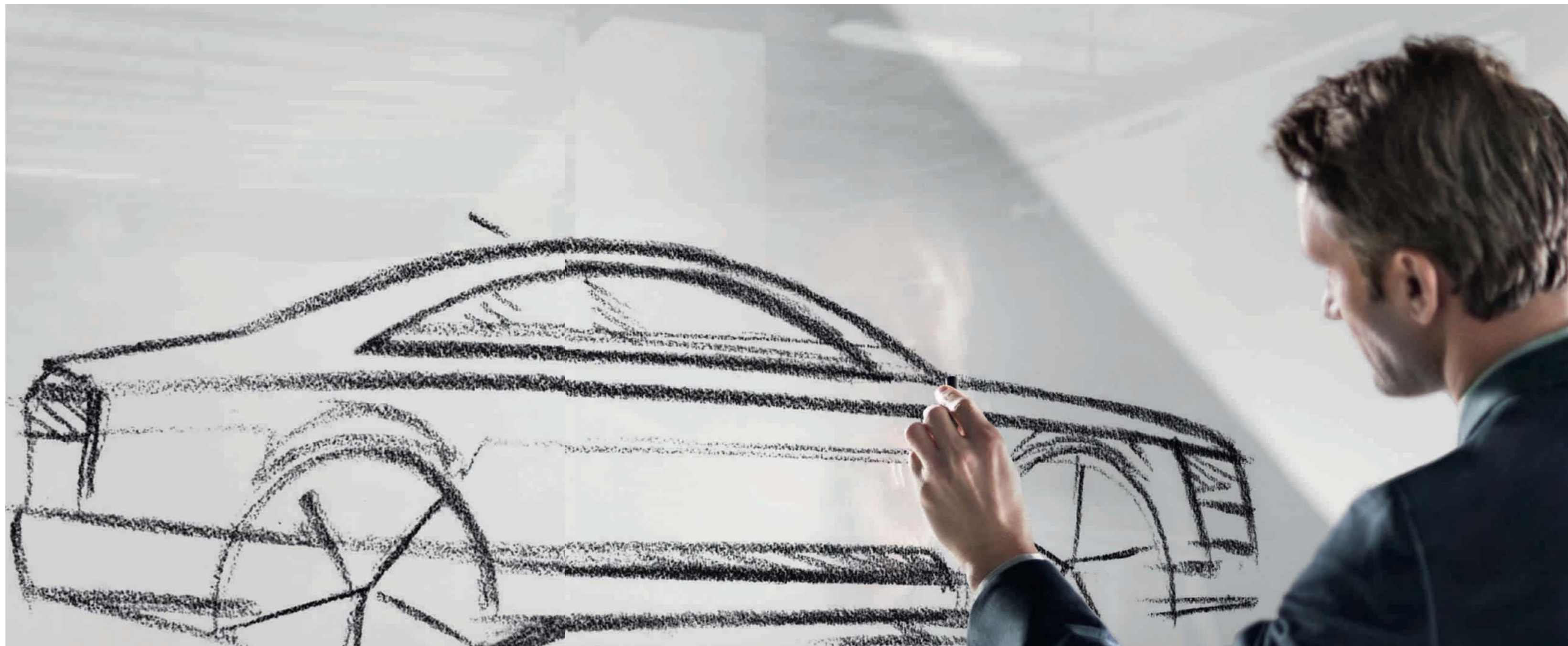



Brilliant design.
Awe-inspiring
and dynamic.

Design



The fuel consumption and CO₂ emission figures can be found on page 96.



**Brilliant
charisma.**
Fascinating
and pioneering.

Design



Comfort



Brilliant comfort.
Exclusive and authentic.



Comfort



Comfort



Welcome aboard the Audi A8. A place where lavish spaciousness is blended with exquisite ambience. Choice materials lend a palpable sense of exclusivity. Top-class workmanship sets new standards. And innovative technology entertains and delights.

Such as the MMI® (1) with its clear layout and elegant design. And which can be operated perfectly with the optional MMI navigation plus with MMI touch (2). Or the optional head-up display (3) that provides eye-level information at all times. The Audi A8. Designed for complete and utter comfort.

The fuel consumption and CO₂ emission figures can be found on page 96.



1



2

Comfort

The Audi A8 L. Supreme power and poise on the outside. And room in abundance on the inside. This is thanks to a wheelbase 13 centimetres longer than on the Audi A8. The result is convincing: even more exclusive space.

Brilliant space.
Elegant and ample.



Comfort

Comfort that invites you to take a seat. Thanks to the larger rear doors. And noticeably more space in the interior. The Audi A8 L. Allow yourself and your ideas all the room you need. Enjoy increased legroom in the rear. For even more relaxed travel or concentrating even better while working. Surrounded by upholstery and trim that is truly in a class of its own: Unicum leather. Vegetable tanned. Breathable. Beautifully soft and yet water and dirt-repellent, too. Full of characteristic features. Unique. Tangible. Mirroring your own personality. In every detail.

The fuel consumption and CO₂ emission figures can be found on page 96.



Dynamics

Impressive performance. 368 kW of power. 625 Nm of torque. Palpable in every driving scenario. 0 to 100 km/h in 4.6 seconds. Achieved with poise and composure, thanks to the exceptionally smooth-running 12-cylinder engine. The Audi A8 L W12: proof that there truly is power in serenity.

**Brilliant
power.
Thrilling
and serene.**



Design

Styling accents which make all the difference. Which emanate strength. Discreetly. Integrated harmoniously into the overall work of art.

Brilliant details in chrome and stainless steel. The Singleframe with close-mesh grille structure and W12 emblem. At once distinctive and elegant. Air inlets with chrome inserts. Exterior mirrors with additional integrated chrome trim. Sophisticated radiance included. Audi Matrix LED headlights as standard. And creating a particularly exclusive look are the optional 20-inch forged aluminium wheels in 15-spoke structured design with a high-gloss polished finish*.





Take your seat for a journey into a different dimension. In comfort seats featuring exquisite leather upholstery. Relax. Enjoy the 4-zone deluxe automatic air conditioning. Or the soothing massage function. In the optional electrically adjustable relaxation seat in the rear. Enjoy the fascinating sensation of space. Complete with LED ambient lighting. Luxury in a new light. Unique. Unmistakeable. The Audi A8 L W12.

The fuel consumption and CO₂ emission figures can be found on page 97.

Design



Charisma. Pure power. And technology of the highest standard. All combined in one of the sportiest saloons around. The Audi S8. Dynamic. Self assured. Visibly progressive. With innovative Audi Matrix LED headlights as an option. Excitingly sporty with a new brilliance.

**Brilliant
technology.
Emphatically
sporty.**



Attention to detail. With a sporty interpretation. With S8-specific 21-inch wheels as an option. Emphatically dynamic. A statement packed with power and confidence. In typical S8 fashion. Three-dimensionally architected Singleframe. Dominantly defined air inlets. The Audi S8. Expressive. Exclusive. Fascinating. A unique experience. Even before you get in.

**Brilliant
facets.
Strikingly
dynamic.**



The fuel consumption and CO₂ emission figures can be found on page 97.

Comfort



The fuel consumption and CO₂ emission figures can be found on page 97.

Dynamics

High-performance athlete with the S factor. 382 kW that respond spontaneously. And thrill. From 0 to 100 km/h in 4.1 seconds. A fascinating build-up of power. An athletic 650 Nm of torque, from just 1,700 rpm. Impressive performance, intelligently controlled. Thanks to Audi cylinder on demand technology. Reduced fuel consumption. Lower emissions. Combined with a thoroughly brilliant performance. The Audi S8. Vorsprung durch Technik.

**Brilliant
performance.
Breathtakingly
athletic.**



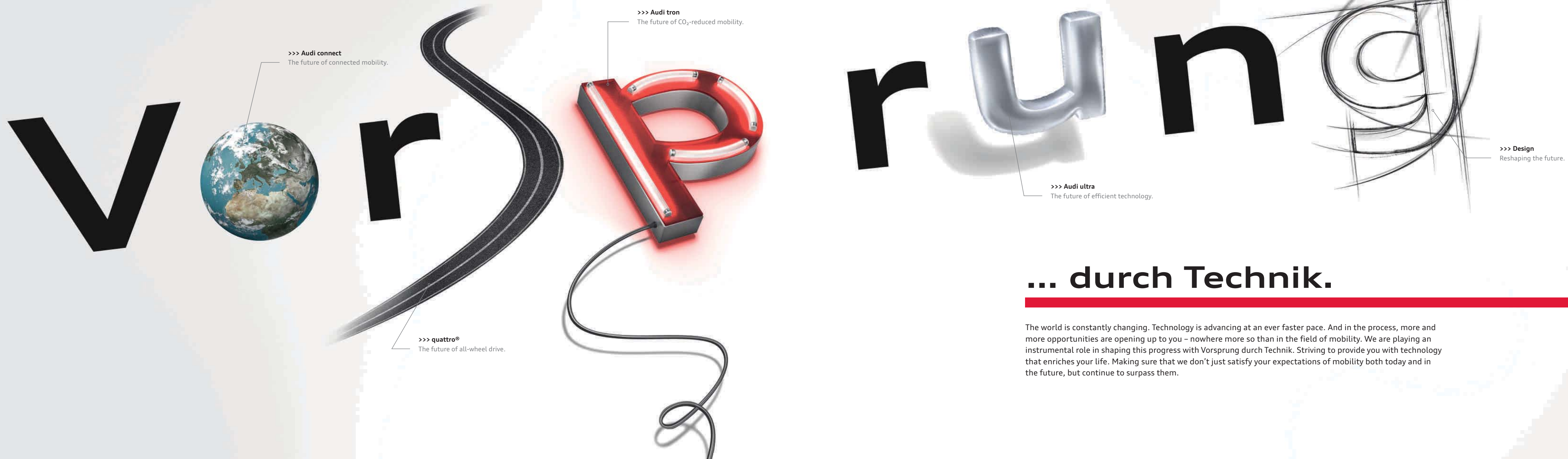

>>> **Audi connect**
The future of connected mobility.

>>> **Audi tron**
The future of CO₂-reduced mobility.

>>> **quattro®**
The future of all-wheel drive.

>>> **Audi ultra**
The future of efficient technology.

>>> **Design**
Reshaping the future.

... durch Technik.

The world is constantly changing. Technology is advancing at an ever faster pace. And in the process, more and more opportunities are opening up to you – nowhere more so than in the field of mobility. We are playing an instrumental role in shaping this progress with Vorsprung durch Technik. Striving to provide you with technology that enriches your life. Making sure that we don't just satisfy your expectations of mobility both today and in the future, but continue to surpass them.

Audi ultra

Perfectly combined.

The future of efficient technologies.

Building an Audi is an extremely complicated business. And yet a simple principle applies for all models: all vehicle components interlock precisely in order to produce emission-reducing synergies. What started in accordance with this principle at the end of the 1980s with Audi lightweight construction and the revolutionary Audi Space Frame (ASF®) is now known as the reversal of the weight spiral: every lightweight component has an impact on other components, which can in turn be made smaller. In this way, existing forms and materials are continuously being improved with regard to their functionality, the lowest possible weight and their production process. With the goal of building vehicles that are even more efficient and make more sparing use of resources. At the same time, more and more efficiency technologies are being built into an Audi. These include recuperation and the start-stop system. Not to mention progressive, efficient high-tech engines. For greater driving dynamics, high compression, more efficient combustion and lower CO₂ emissions. All this is known as Audi ultra. Today and in the future – towards CO₂-reduced mobility.

>>> Aerodynamics

Less drag, more efficiency. Thanks to the consistently aerodynamic styling of the vehicle's lines, its underbody and spoiler edges – in order to achieve the best possible form for aerodynamic efficiency. Not forgetting tyres with reduced rolling resistance. All tested in the Audi wind tunnel at up to 300 km/h.

>>> Lightweight expertise

Less weight. More savings, power and endurance. Audi lightweight technology. What started with lightweight body construction has now made its way into nearly all areas, combining innovative materials such as aluminium, carbon and magnesium, intelligent design principles and resource-saving manufacturing processes into an overall concept.

>>> Transmission expertise

Improved efficiency thanks to improved transmission ratios. A higher torque output makes longer ratios possible, especially in higher gears. For powerful torque in the low engine speed range which reduces consumption – yet has no adverse effects on driving performance and sportiness.

>>> Recuperation

Braking that leads to even more efficient driving. With brake energy recovery (recuperation). Part of the kinetic energy produced when braking and coasting is temporarily stored in the vehicle's battery and then used when accelerating. Depending on the driving cycle, this can save up to 3% of fuel.

>>> Engine expertise

Powerfully and efficiently driven. By Audi ultra with efficiency technologies in the engine sector. Such as Audi cylinder on demand and the Audi valvelift system, which both reduce the amount of energy consumed by the engine, or clean diesel technology, which can help to reduce emissions.

Mobility & navigation



Point-of-interest (POI) search with voice control
in the Google™* database



Traffic information online
complements the dynamic route guidance with real-time traffic flow information for individual stretches of road



Fuel prices
the cheapest petrol stations at your destination or in the vicinity



Parking information
Help with looking for car parks and multi-stores, plus – where available – information on prices and currently vacant spaces



Country information
The legal regulations for a specific country, such as speed limits or whether it is compulsory to carry a high-visibility vest, can be called up at any time in the MMI at the push of a button.



Navigation with Google Earth™* and Google Street View™*
uses high-resolution aerial and satellite images, photos and address information to guide you to your destination even more easily



Destination entry via myAudi or Google Maps™*
If you want, you can plan your navigation destinations from your home computer. myAudi and Google Maps™* allow individual navigation destinations to be sent to the vehicle. When you start your journey, these can easily be loaded as your destination.



Communication



Wi-Fi hotspot
connects your mobile devices to the internet



If you want to experience the full diversity of Audi connect, scan this QR code using your smartphone. Or follow this link in your browser: www.audi.com/audiconnecta8

myAudi – your personal control centre
provides you with password-protected access to www.audi.com/myaudi where, following one-off registration, you are able to manage the services supported by Audi connect and configure them from the comfort of your own home

* Google and the Google logo are registered trademarks of Google Inc.

Availability, screen display and the cost of services vary depending on the country, model, device and tariff. For further legal information and notes on use, please see page 89 or visit www.audi.com/connect. The fuel consumption and CO₂ emission figures can be found from page 96 onwards.

Audi connect.

Audi connect

The future of connected mobility.

The world presents you with countless possibilities. Audi connect enables you to make the most of many of them in digital form directly from your Audi A8. At the push of a button. Tailored to you. Thanks to myAudi and the services supported by Audi connect in your Audi A8. In places all over the world. Intuitively, easily and conveniently.

Infotainment



Weather
forecasts and maps for the required destination



Audi music stream
access to global radio stations via smartphone app and Wi-Fi, plus access to your smartphone's media library



News online
text and images about current world events



City events
up-to-date information about events – e.g. at your destination



Travel information
sightseeing information – with a function for importing destination to the navigation system

Have the road completely under control, thanks to permanent distribution of the drive force to all four wheels. Variably controlled by the centre differential. Always depending on the situation. Experience handling stability, dynamism and agility as never before and combat the effects of over- and understeer with quattro with optional sport differential. For increased traction and superior propulsive power. Tame any road. And always keep your eyes set on where you're heading. In bends. On straights. Over any surface. For a fascinating experience that sticks. To the road – and in your mind.



quattro®
**Stick to
the road.**

With quattro®.



Audi Matrix LED headlights

See well.

Darkness is relative. The optional Audi Matrix LED headlights turn night into day. The all-new headlight technology produces a light colour similar to that of daylight. Bends are anticipated to illuminate them more clearly. Vehicles are detected and the light distribution of your Audi A8 adapts according to the situation. This is all made possible by an array of sensors and a camera. As well as dimmable LEDs in an innovative arrangement – which, incidentally, are quite a sight in their own right.



Convincingly illuminating – the video on the Audi Matrix LED headlights. Scan this QR code with your smartphone and see for yourself. Or follow this link in your browser: www.audi.com/a8matrixledscheinwerferfilm



Audi Matrix LED headlights won't thrill you only at night. The new lighting technology is quite a spectacle during the day, too, sometimes appearing as light points, sometimes as a dynamic light strip. Individually controllable LEDs. Perfectly adapted to the situation in hand. Showing the way ahead. An impressive sight, time and time again.

The fuel consumption and CO₂ emission figures can be found from page 96 onwards.

Look good.

Maximum power. Put to maximum use.

Every movement originates from something. Something that sets it off, an idea. The engine for your Audi A8 can also be traced back to an initial spark of inspiration: higher power with lower fuel consumption. These apparently conflicting aims are reconciled in two revolutionary drive technologies: TDI and TFSI. Get acquainted with both of them. And then opt for the drive system that you feel most moved by.



The fuel consumption and CO₂ emission figures can be found from page 96 onwards.



TDI®

With their combination of direct injection and turbocharging, Audi TDI engines promise exceptional performance – thanks to their high torque output over the entire engine speed range with constant power build-up. They are renowned for being fuel-efficient and for reducing emissions. But they are incredibly dynamic too – letting you get the maximum out of any road.



TFSI®

Audi TFSI engines attain a particularly high compression rate. The result: outstanding efficiency combined with optimum performance. Substituting supercharging for cubic capacity has the effect of considerably reducing engine size and weight – while performance remains as impressively dynamic as ever. For power delivery that will win you over from the word go.

Audi cylinder on demand

Even cylinder heads can be intelligent, as Audi cylinder on demand proves. Four of the eight cylinders of the 4.0 litre V8 TFSI engine and six of the twelve cylinders of the 6.3 litre W12 FSI engine automatically shut down in the partial-load range. This helps to lower fuel consumption at the same time as reducing emissions. Without the switchover even being noticed or impairing the driving dynamics.



hybrid

Brake to accelerate.

Get further ahead every time you use the brakes. Turn braking energy into fuel efficiency. First store it in a lithium-ion battery. Then put it to sustainable use. Experience efficient mobility. Purely on electricity if you want. Up to 3 kilometres at a constant 60 km/h. And even up to 100 km/h for a short period. Completely emission-free during coasting. When the vehicle is in overrun, the combustion engine is switched off and kinetic energy is all that is keeping you moving. Even at speeds of up to 160 km/h. Feel the additional benefit of high-torque dynamics when boosting. Just as soon as the combustion engine and electric motor work together. For faster acceleration, higher flexibility and greater driving enjoyment.



>>> Combustion engine

Among the hybrid engine versions in the Audi A8, the 2.0 litre TFSI engine is at once both efficient and powerful. The 155 kW engine has increased torque, direct fuel injection, turbocharging and the Audi valvelift system. In conjunction with the electric motor, which is also a high-torque unit, the dynamism produced is the equal of any other drive type.

>>> Electric motor

Traction motor, alternator and starter in one: the compact and lightweight 40 kW electric motor in the Audi A8 hybrid and A8 L hybrid. It is connected to the crankshaft via a separating clutch, thus ensuring that the available power is transmitted directly. This parallel hybrid concept delivers convincing drive-off performance and acceleration in just about every driving situation. Together, the combustion engine and electric motor deliver a system output of 180 kW.

>>> Lithium-ion battery (including battery cooling)

The lithium-ion battery in the Audi A8 hybrid and A8 L hybrid allows you to drive purely on electricity for a certain period. It determines the range and output of the hybrid drive, and its high energy density means significantly more power. Its low weight and space-saving design are also bound to impress. Including active battery cooling, which improves the availability of the hybrid system and prolongs its operating life.

>>> adaptive air suspension

The electronically controlled air suspension acts individually at each of the 4 wheels and makes sure that the handling characteristics are barely affected, even when carrying heavy loads.

>>> adaptive air suspension – sport

Depending on the mode, the sport version of the air suspension lowers the ride height by up to 10 mm compared to adaptive air suspension and has even stiffer damping.

>>> tiptronic

The 8-speed automatic transmission with Dynamic Shift Program (DSP) ensures faster gear changes without any perceptible break in propulsive power.

>>> Audi drive select

Audi drive select lets you adjust the driving characteristics of the A8 to suit your requirements. At the push of a button. Sportier, more comfortable, more balanced, more economical or even individually tailored as you please. It's entirely up to you.

>>> Dynamic steering

The dynamic steering enhances handling and driving comfort with speed-sensitive control of the steering ratio.

>>> Electromechanical power steering

The speed-sensitive power steering conveys a precise steering feel even at high speeds, helps you to countersteer and makes light work of parking.

>>> quattro®

The permanent all-wheel-drive system distributes the drive forces to each individual wheel according to the driving situation for extra traction and dynamic performance.

>>> quattro® with sport differential

The quattro permanent all-wheel drive with electronically controlled sport differential guarantees superb agility and thrilling driving dynamics.

>>> Ceramic brake

The ceramic brakes available for the front and rear axles ensure excellent braking performance in any driving situation.

Dynamics

Dynamics

that will take a hold of you.

Get in. Buckle up. Start the engine. Wherever you're heading, enthralling driving dynamics will power you there. For as you know, the world is your oyster once you get behind the wheel of your Audi A8. You decide the direction. The driving style. The pace. And you enjoy the satisfaction of knowing you have plenty in reserve. More than enough to get the very best from every drive.

The fuel consumption and CO₂ emission figures can be found from page 96 onwards.

You can find out which equipment features are available as standard or optional in your model by referring to the index starting on page 102.

Assistance systems

Wherever you're heading, peace of mind will be your constant companion.

With the assistance systems in your Audi A8.

Each drive is different. Yet they all have one thing in common – the feeling of being protected that you get from every Audi. All driver assistance systems in your Audi A8 help you during your journey and guarantee even greater comfort when you're on the road. Get to know the most important driver assistance systems.

>>> Audi pre sense basic

initiates preventive occupant protection measures in the event of an impending accident

>>> adaptive cruise control with Stop&Go function and Audi pre sense front

monitors the traffic ahead and automatically maintains a constant distance wherever possible

>>> Camera-based speed limit display

recognises speed limits and notifies you of them via the driver information system and head-up display

>>> Audi Matrix LED headlights

track the road ahead and illuminate it according to the situation with their innovative LED layout for even greater safety

>>> Audi active lane assist

helps you to keep in lane by means of gentle steering intervention when lane boundary markings are detected

>>> Night vision assistant

improves convenience at night thanks to its integrated thermal imaging camera, highlighting any pedestrians and larger wild animals detected

>>> Audi side assist including Audi pre sense rear

helps you when changing lanes and initiates preventive protection measures when an impending rear-end collision is detected

>>> Head-up display

projects key information onto the windscreen at eye level so there is no need to take your eyes off the road

>>> Parking system plus with 360 degree cameras

provides a better overview for parking and manoeuvring by offering a choice of different camera angles all around the vehicle

>>> Park assist with display of surroundings

helps you to manoeuvre in and out of parking spaces by performing steering actions autonomously

>>> Audi connect

Use all the services supported by Audi connect with the MMI – quickly and easily. The intuitive operation of the MMI makes accessing the internet remarkably straightforward.

>>> Car

Control and alter driver assistance systems, vehicle settings as well as climate control and service functions quickly and easily using the MMI.

>>> Media

Browse through the covers of your music collection on all available media sources such as inserted SD cards, Audi music interface, CDs or DVDs.

>>> Navigation

Let yourself be guided to your destinations with even greater ease by the 3D map view and 3-dimensional display of places of interest and landmark buildings.

>>> Phone

Make phone calls safely and easily using the hands-free facility: simply select the number to dial from your contacts in the MMI or enter the number intuitively via the MMI touch.

>>> MMI® navigation plus with MMI touch

The MMI navigation plus with MMI touch in the Audi A8 makes operating the individual components of the Multi Media Interface even easier. The touchpad integrated next to the rotary/push-button control can even be operated using just one finger.

**Simplicity****The MMI® – intelligent, individual, intuitive.**

Streamlined. Simple. Logical. The world of mobile infotainment completely redefined: the Multi Media Interface (MMI). Phoning, navigating or surfing the internet via Audi connect: all highly intuitive, highly functional and highly convenient – not least thanks to voice control. With the MMI in your Audi A8, everything will be child's play for you.



As unique as you are. The equipment options.

Sportiness, comfort, design, functionality – whatever you demand of your Audi, it offers you a wealth of custom options. Here you will see just how much attention we pay to detail. And to quality that you can appreciate with all your senses. From exquisite inlays and the extended range of interior colours to superior quality leather: in an Audi A8 you can enjoy not just innovative technology, but also luxurious craftsmanship beyond your expectations.

Sportiness that can be seen and felt. Even when stationary.

S stands for sportiness. The Audi S8 is impressive proof of this. With extensive S-specific equipment. For a dynamic look. Sporty comfort. And superior performance. And you also have the option of further enhancing the S-factor. With optional equipment that is equally impressive to the senses.



S8-specific standard equipment

Cast aluminium wheels
in 5-parallel-spoke design (S design)
size 9 J x 20 with 265/40 R 20 tyres*

Black painted brake callipers
with S8 logo at front

Audi Singleframe
radiator protective grille in platinum grey with horizontal double chrome struts and S8 emblem

Front bumper
in a distinctive sporty design with honeycomb-structure air intake grilles and double chrome struts; includes aluminium-look blade

Exterior mirror housings
in aluminium look

Side sill trims
in body colour; distinctive, sporty design

Diffuser insert at rear
in platinum grey, edged with two-layer blade in aluminium look

Exhaust tailpipes
dual-branch design, 2 oval chrome surrounds on both left and right

Model name/logo
· S8 emblem in Audi Singleframe, on the luggage compartment lid and on the vehicle key
· V8 T logo on the front wings

Door sill trims with aluminium inlays
with S8 logo, illuminated

Pedals and footrest in stainless steel

S-specific instrument cluster
with grey dials, white needles and S8 logo in the rev counter; dynamic ready-check feature

Multifunction sport leather steering wheel in 3-spoke design with shift paddles in aluminium look
with S8 emblem and S-specific stitching

Selector lever in carbon Atlas
with shift-by-wire technology; in conjunction with Audi design selection Vermont brown in piano finish, black

Engine start-stop button, S-specific
with red ring

S8-specific analogue clock with grey dial

Comfort sport seats, front

Seat upholstery in Valcona leather, lunar silver/steel grey
with square perforations and diamond-patterned stitching

Upper/lower inlays
carbon Atlas/brushed aluminium, silver

adaptive air suspension – sport
with S8-specific tuning

quattro® with sport differential
with S8-specific tuning

Dynamic steering
with S8-specific tuning

S8-specific optional equipment

Paint finish in the special colour Daytona grey, pearl effect

Cast aluminium wheels
in 5-triple-spoke design (S design)
size 9 J x 21 with 265/35 R 21 tyres*

Cast aluminium winter wheels
in 5-parallel-spoke design (S design)
size 9 J x 20 with 265/40 R 20 tyres*

Audi design selection Vermont brown with inlays in carbon red

Sport exhaust system
for an even greater sound experience; dual-branch design with 2 oval tailpipes each left and right; high-gloss black surrounds

The right driving force for every personality.

No matter which Audi engine you choose, they all have high compression ratios, highly efficient combustion and outstanding efficiency. In short, they deliver more power whilst using less fuel and producing fewer emissions.



4.2 TDI

TDI®

Audi TDI engines: high torque output over the entire engine speed range – with constant power build-up. They are renowned for being fuel-efficient and for reducing emissions. The 3.0 TDI clean diesel quattro, for example, has a power output of 190 kW, a regulated top speed of 250 km/h and accelerates from 0 to 100 km/h in 5.9 seconds.

- A8 3.0 TDI clean diesel quattro (190 kW)
- A8 4.2 TDI clean diesel quattro (283 kW)



4.0 TFSI

TFSI®

The Audi TFSI engines offer outstanding efficiency and improved performance whilst at the same time retaining their dynamism. The 4.0 TFSI quattro in the Audi A8, for example, has a power output of 320 kW, enabling the car to accelerate from 0 to 100 km/h in 4.5 seconds and reach a regulated top speed of 250 km/h.

- A8 3.0 TFSI quattro (228 kW)
- A8 4.0 TFSI quattro (320 kW)
- S8 4.0 TFSI quattro (382 kW)
- A8 hybrid 2.0 TFSI (155 kW)



6.3 FSI

FSI®

The Audi W12 engine combines superb acceleration and powerful torque with exceptionally quiet operation. The Audi A8 L W12 6.3 FSI quattro has an impressive power output of 368 kW and accelerates from 0 to 100 km/h in 4.6 seconds. Its regulated top speed is 250 km/h.

- A8 L W12 6.3 FSI quattro (368 kW)

The fuel consumption and CO₂ emission figures can be found from page 96 onwards.

As unmistakable as your standards: the Audi design selection.

The Audi design selection offers you an attractive pre-selection of exclusive materials and colours for the interior. Our designers have combined inlays of fine woods or carbon and brushed aluminium with exquisite leather seats featuring attractive contrasting stitching. First-class comfort functions complete the exclusive range of Audi design selection.



Audi design selection Vermont brown

The Audi design selection Vermont brown includes the following:

- Comfort sport seats in Valcona leather, Vermont brown with accordion pleats, contrasting stitching and piping in granite grey
- Seat belts in black
- Headlining, upper pillar trim and sun visors in Alcantara, lunar silver (optionally available in Alcantara, black)
- Rear parcel shelf in Alcantara, black
- Multifunction sport leather steering wheel in 3-spoke design in black with S-specific contrasting stitching in Vermont brown, S8 emblem and aluminium-look shift paddles
- Selector lever in piano finish, black
- Top side of dashboard in black with stitching in black
- Underside of dashboard in black
- Door armrest, centre console and knee pad in black with contrasting stitching in Vermont brown
- Door trim inserts in Alcantara, black
- Centre console and wood trim on the back of the front seats in piano finish, black
- Carpet and floor mats in velour, black
- Upper inlay in carbon red

Additional equipment:

- Metallic or pearl effect paint finish
- Seat heating, front and rear
- Seat ventilation and massage function, front
- Comfort head restraints, rear
- 4-zone deluxe automatic air conditioning
- Full-leather package including headlining and rear parcel shelf in Alcantara as well as electric sunblinds on the rear window and on the rear door windows
- design selection emblem in the door trims





Audi design selection sycamore grey

The Audi design selection sycamore grey includes the following:

- Comfort seats in Valcona leather, sycamore grey with accordion pleats, contrasting stitching and piping in brass gold
- Seat belts in black
- Headlining, upper pillar trim and sun visors in Alcantara, snow white
- Rear parcel shelf in Alcantara, sycamore grey
- Multifunction leather steering wheel in marble grey with shift paddles
- Selector lever in leather, marble grey
- Top side of dashboard in marble grey with contrasting stitching in sycamore grey or brass gold
- Underside of dashboard in sycamore grey
- Door armrest, centre console and knee pad in sycamore grey with contrasting stitching in brass gold
- Door trim inserts in Alcantara, sycamore grey
- Centre console and wood trim on the back of the front seats in fine grain ash, natural pearl grey
- Carpet and floor mats in velour, sycamore grey
- Upper inlay in fine grain ash, natural pearl grey
- Lower inlay in brushed aluminium, silver

Additional equipment:

- Metallic or pearl effect paint finish
- Comfort centre armrest, front
- Seat heating, front and rear
- Seat ventilation and massage function, front
- Comfort head restraints, rear
- 4-zone deluxe automatic air conditioning*
- Ambient lighting
- Full-leather package including headlining and rear parcel shelf in Alcantara as well as electric sunblinds on the rear window and on the rear door windows
- Extended aluminium-look interior
- design selection emblem in the door trims



Audi design selection Balao brown

The Audi design selection Balao brown includes the following:

- Comfort seats in Valcona leather, Balao brown with accordion pleats, contrasting stitching and piping in snow white
- Seat belts in black
- Headlining, upper pillar trim and sun visors in Alcantara, snow white
- Rear parcel shelf in Alcantara, Balao brown
- Multifunction leather steering wheel in mocca brown with shift paddles
- Selector lever in leather, mocca brown
- Top side of dashboard in mocca brown with contrasting stitching in snow white or mocca brown
- Underside of dashboard in Balao brown
- Door armrest, centre console and knee pad in Balao brown with contrasting stitching in snow white
- Door trim inserts in Alcantara, Balao brown
- Centre console and wood trim on the back of the front seats in fine grain ash, natural balsamic brown
- Carpet and floor mats in velour, Balao brown
- Upper inlays in fine grain ash, natural balsamic brown
- Lower inlay in brushed aluminium, silver

Additional equipment:

- Metallic or pearl effect paint finish
- Comfort centre armrest, front
- Seat heating, front and rear
- Seat ventilation and massage function, front
- Comfort head restraints, rear
- 4-zone deluxe automatic air conditioning*
- Ambient lighting
- Full-leather package including headlining and rear parcel shelf in Alcantara as well as electric sunblinds on the rear window and on the rear door windows
- Extended aluminium-look interior
- design selection emblem in the door trims



*For A8 hybrid and A8 L hybrid with 3-zone deluxe automatic air conditioning.

You have an exclusive character. So why shouldn't your Audi have one too?

That the Audi exclusive range aspires to exclusivity is already evident from its name. Selected décors and coloured leather can be combined with customised paint finishes from the large selection of Audi exclusive colours to suit your own personal preferences. So you can highlight your car's exceptional character to even better advantage. Your Audi partner and the Audi exclusive Studio of the Audi Forum Neckarsulm await your wishes.



Audi A8 L with Audi exclusive customised paint finish in saddle brown, pearl effect

Audi Sport cast aluminium wheels in 5-arm structured design

Audi exclusive leather upholstery and trim (package 4) in magnolia/chestnut brown

Comfort sport seats, front in Valcona leather, magnolia; stitching, accordion pleats and seat side bolsters in chestnut brown

Upper inlay in piano finish, black and lower inlay in high-gloss black

Audi exclusive carpet and floor mats in magnolia with leather piping in chestnut brown



The selector lever in leather, colour-coordinated with your choice of interior colour, sits pleasantly softly in the hand. The inlays in piano finish, black create a sporty yet elegant look. The exquisite ambience is rounded off by the comfort sport seats in magnolia with accordion pleats and stitching on seat side bolsters and head restraints in chestnut brown. The shaped seat side bolsters provide for comfortable lateral hold, the seat centre panels in diamond-patterned stitching for pleasant seating comfort.

These are just a few ideas for how you can customise your A8. Find out more: your Audi partner and the Audi exclusive Studio of the Audi Forum Neckarsulm await your wishes.



The fuel consumption and CO₂ emission figures can be found on page 96.

| Extract from the range of Audi exclusive paint finishes

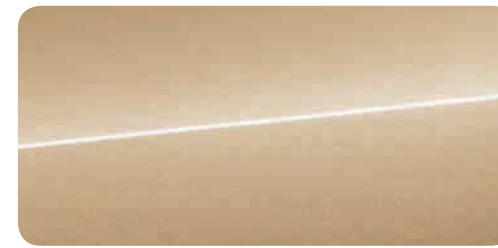

Sand beige, pearl effect

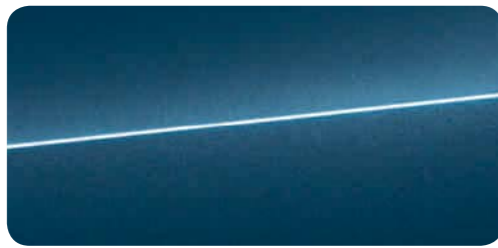

Palace blue, pearl effect



Audi exclusive customised paint finishes
Individual choice of colour

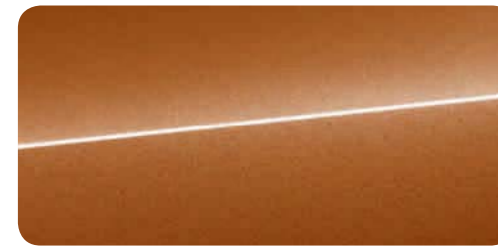

Ipanema brown, metallic

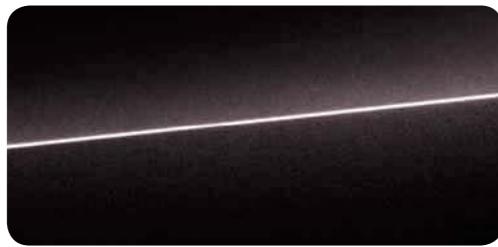

Saddle brown, pearl effect

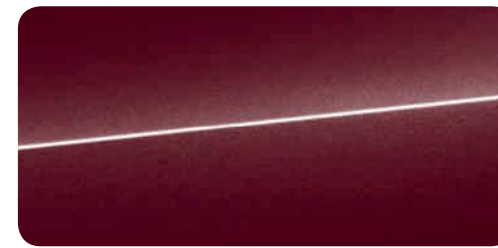

Classic red, pearl effect

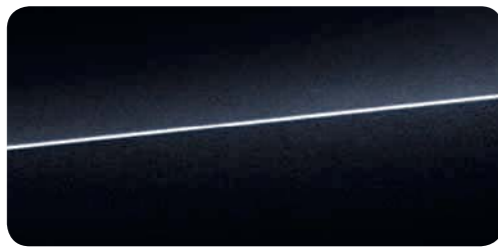

Mamba black, metallic

| Extract from the range of Audi exclusive leathers



Valcona leather, alabaster white



Valcona leather, powder beige



Valcona leather, saddle brown



Valcona leather, classic red



Valcona leather, magnolia



Valcona leather, Havana brown



Valcona leather, chestnut brown



Valcona leather, jet grey



Valcona leather, sand beige



Valcona leather, cognac



Valcona leather, crimson red



Valcona leather, cloudy grey

| Extract from the range of Audi exclusive inlays

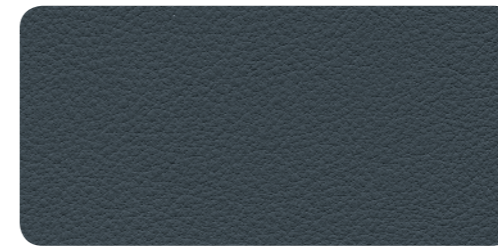

Valcona leather, smoky blue



Modrone, gold



Tamo ash, natural dark brown



Piano finish, black



Valcona leather, night blue



Vavona, bronze



Fine grain myrtle, nutmeg



Valcona leather, Iceland green



Fine grain ash, nougat



Oak, sepia

Seat upholstery optionally also in Alcantara (except crimson red)

Brilliant character. Exquisite and unique – the A8 Audi exclusive concept.

The strictly limited-edition Audi A8 L W12 combines outstanding material quality with brilliant individuality. Exquisite leather from the Italian luxury design house Poltrona Frau and fine wood trim combine to turn this already peerless vehicle into a unique one. The natural grain of the leather, for example, mirrors the car's distinctive character. Experience a new definition of exclusive comfort. In a car of which only fifty will ever exist in the entire world. A unique definition of personal comfort.



The A8 Audi exclusive concept from quattro GmbH.



Highlights

Audi exclusive mineral grey, metallic customised paint finish.

Leather upholstery and trim from Poltrona Frau in Agatha cognac and Valcona leather in granite grey with diamond-patterned stitching on the seat centre panels in Agatha cognac

Seat side bolsters with Poltrona Frau embossing

Inlays in fine grain ash, olive-patterned natural silver brown

Headlining in Alcantara, snow white

Audi exclusive carpet and floor mats in jet grey; leather piping on floor mats from Poltrona Frau in Agatha cognac with contrasting stitching in jet grey

Audi exclusive seat belts in Agatha cognac

Audi exclusive concept door sill trims with corresponding limited-edition number (1/50)

Includes a leather care kit

The fuel consumption and CO₂ emission figures can be found on page 97.

Your Audi is painted not just once. But four times.

When you choose a paint colour, choose one that best reflects your own personality. But whichever colour you opt for, you can count on the outstanding quality of our painting process. Though no thicker than a human hair, the layer of paint on an Audi is actually made up of four different coats. So not only do you look radiant in your Audi A8, the car is also optimally protected from environmental influences and wear. For its entire lifetime.

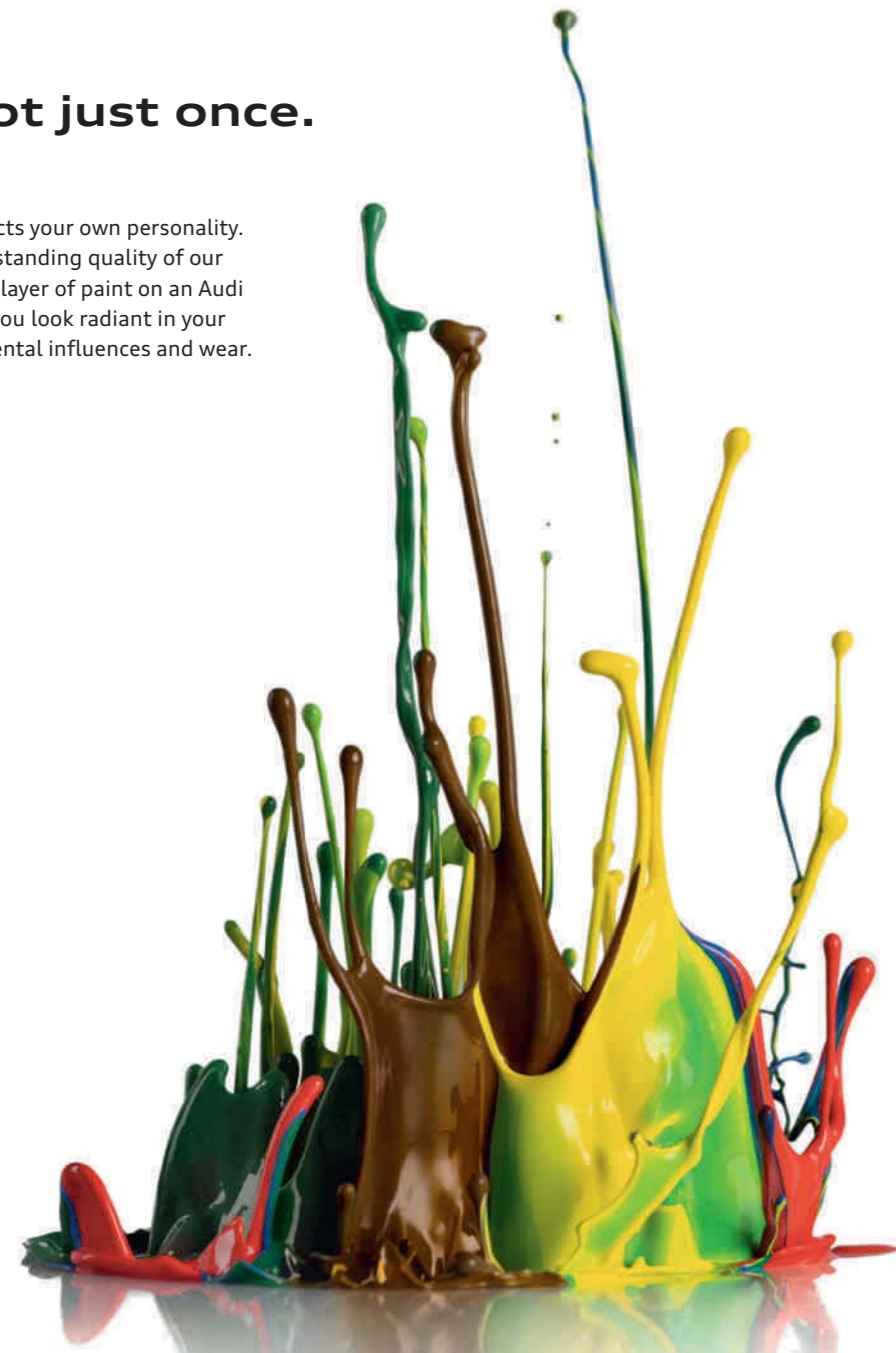

| Solid paint finishes



Ibis white

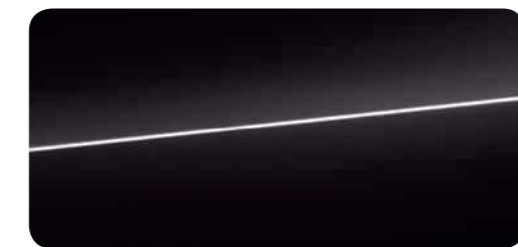

Brilliant black

| Metallic paint finishes



Havana black, metallic



Oolong grey, metallic



Floret silver, metallic

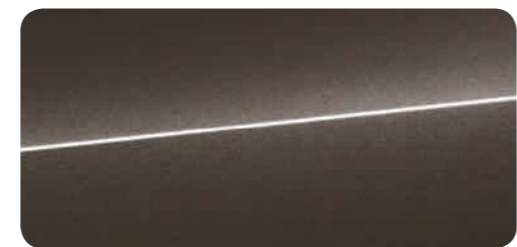

Argus brown, metallic

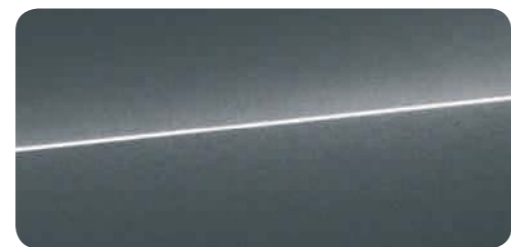

Monsoon grey, metallic



Glacier white, metallic



Moonlight blue, metallic



Cuvée silver, metallic

The model-specific standard and optional equipment can be found in the index from page 102 onwards.
The fuel consumption and CO₂ emission figures can be found from page 96 onwards.

Exterior
Paint finishes Wheels/tyres

| Pearl effect paint finishes

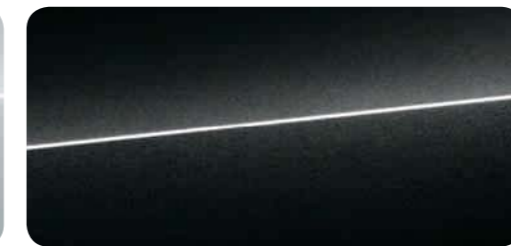

Phantom black, pearl effect

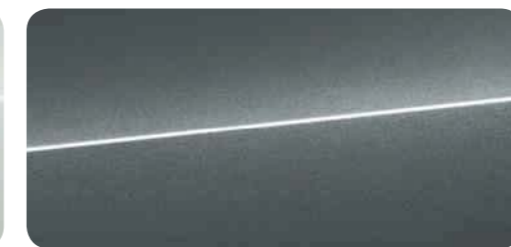

Daytona grey, pearl effect
Only available for the S8

| Customised paint finishes



Audi exclusive customised paint finishes
From quattro GmbH.
An extract from the range of Audi exclusive paint finishes can be found on page 64.



Quality given form. And a brilliant finish. Audi wheels.

To make sure you have peace of mind for every metre of your drive, Audi puts its wheels through an exacting series of specialised test procedures. Hardness tests, for example, aim for maximum stability, while a copper accelerated salt spray test – or CASS for short – using acetic acid guarantees the greatest possible corrosion protection. Thanks to these and many other measures, we can ensure that every Audi wheel offers maximum quality – even after scores of kilometres. No matter which of the numerous designs you choose.

| Summer wheels



Forged aluminium wheels in 6-arm design
size 8 J x 17 with 235/60 R 17 tyres¹



Cast aluminium wheels in 5-arm design
size 9 J x 19 with 255/45 R 19 tyres¹
(optionally available with run-flat tyres)



Cast aluminium wheels in 10-spoke V design
size 8 J x 18 with 235/55 R 18 tyres¹



Cast aluminium wheels in 10-spoke Y design, partly polished²
size 9 J x 19 with 255/45 R 19 tyres¹
(optionally available with run-flat tyres)



Cast aluminium wheels in 10-arm turbine design (hybrid design)
size 8 J x 18 with 235/55 R 18 tyres¹.
Available only for the A8 hybrid and A8 L hybrid



Cast aluminium wheels in 10-arm turbine design (hybrid design),
contrasting grey, partly polished²
size 9 J x 19 with 255/45 R 19 tyres¹.
Available only for the A8 hybrid and A8 L hybrid



Cast aluminium wheels in 15-spoke design, partly polished²
size 9 J x 19 with 255/45 R 19 tyres¹
(optionally available with run-flat tyres)



Cast aluminium wheels in 10-spoke star design
size 9 J x 20 with 265/40 R 20 tyres¹



Forged aluminium wheels in 15-spoke structured design, partly polished²
size 9 J x 20 with 265/40 R 20 tyres¹



Audi Sport cast aluminium wheels in 5-twin-spoke design in matt titanium look, gloss turned finish²
size 9 J x 20 with 265/40 R 20 tyres¹.
From quattro GmbH



Audi Sport cast aluminium wheels in 15-spoke design in matt titanium look, gloss turned finish²
size 9 J x 19 with 255/45 R 19 tyres¹
(optionally available with run-flat tyres).
From quattro GmbH



Forged aluminium wheels in 10-parallel-spoke design, partly polished²
size 9 J x 20 with 265/40 R 20 tyres¹



Forged aluminium wheels in 15-spoke structured design, high-gloss polished finish²
size 9 J x 20 with 265/40 R 20 tyres¹.
Available only for A8 L W12



Audi Sport cast aluminium wheels in 5-spoke blade design
size 9 J x 20 with 265/40 R 20 tyres¹.
From quattro GmbH



Audi Sport cast aluminium wheels in 7-twin-spoke design
size 9 J x 19 with 255/45 R 19 tyres¹
(optionally available with run-flat tyres).
From quattro GmbH



Cast aluminium wheels in 5-parallel-spoke design (S design)
size 9 J x 20 with 265/40 R 20 tyres¹.
Available only for the S8



Audi Sport cast aluminium wheels in 5-twin-spoke design
size 9 J x 20 with 265/40 R 20 tyres¹.
From quattro GmbH



Audi Sport cast aluminium wheels in 10-Y-spoke design
size 9 J x 20 with 265/40 R 20 tyres¹.
From quattro GmbH



Cast aluminium wheels in 5-triple-spoke design (S design)
size 9 J x 21 with 265/35 R 21 tyres¹.
Available only for the S8



Audi Sport cast aluminium wheels in 5-arm rotor design in matt titanium look, gloss turned finish²
size 9 J x 21 with 275/35 R 21 tyres¹.
From quattro GmbH



Audi Sport cast aluminium wheels in 5-arm structured design
size 9 J x 21 with 275/35 R 21 tyres¹.
From quattro GmbH



Audi Sport cast aluminium wheels in 5-arm rotor design
size 9 J x 21 with 275/35 R 21 tyres¹.
From quattro GmbH

| Winter wheels



Cast aluminium winter wheels in 6-arm design
size 7.5 J x 17 with 235/60 R 17 tyres¹,
permissible top speed 210 km/h,
can be fitted with snow chains



Cast aluminium winter wheels in 5-parallel-spoke design (S design)
size 9 J x 20 with 265/40 R 20 tyres¹,
permissible top speed 240 km/h,
cannot be fitted with snow chains.
Available only for the S8



Cast aluminium winter wheels in 7-arm design
size 7.5 J x 18 with 235/55 R 18 tyres¹,
permissible top speed 210 km/h,
can be fitted with snow chains



Forged aluminium winter wheels in 10-parallel-spoke design
size 9 J x 20 with 265/40 R 20 tyres¹,
permissible top speed 240 km/h,
cannot be fitted with snow chains



Cast aluminium winter wheels in 5-arm design
size 7.5 J x 19 with 235/50 R 19 tyres¹,
permissible top speed 210 km/h,
can be fitted with snow chains
(optionally available with run-flat tyres)

¹The model-specific standard and optional equipment can be found in the index from page 102 onwards.

²You will find specifications on the technical characteristics of tyres on page 99. ³Please note the special information relating to wheels on page 99.

Premium quality you can rely on.

You have a special place in your Audi. Exclusive comfort can be felt on the front and rear seats: thanks to high-quality materials and first-class workmanship. Regardless of which seat upholstery you choose, or whether you prefer the comfort seats or comfort sport seats for dynamic driving: you're sitting in the right place.



Standard seats, front 1

Also available with memory function².
The image shows standard seat, front, in Valcona leather, velvet beige.

The model-specific standard and optional equipment can be found in the index from page 102 onwards.



Comfort seats, front 2
Comfort seats, front with seat ventilation 3

Both seat variants include memory function² and wood trim on the back of the front seats; Comfort seats, front, with seat ventilation and perforated leather. The image shows comfort seat, front in Valcona leather, velvet beige without seat ventilation.

¹ In conjunction with memory function for standard seats, front. ² Further information on the memory function can be found on page 76 of this brochure.



Comfort sport seats, front 4
Comfort sport seats, front with seat ventilation 5

Both seat variants include memory function², wood trim on the back of the front seats and perforated leather upholstery. The image shows comfort sport seat, front in Valcona leather, velvet beige with massage function.

Interior

Seats/headlinings Inlays

I Cloth



Verdi cloth



Valcona leather, nougat brown



Valcona leather, titanium grey



Valcona leather, velvet beige



Valcona leather, nougat brown with round perforations

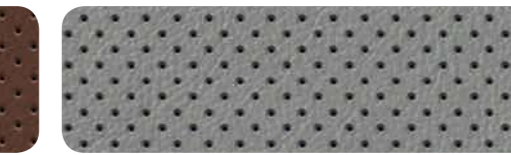

Valcona leather, titanium grey with round perforations

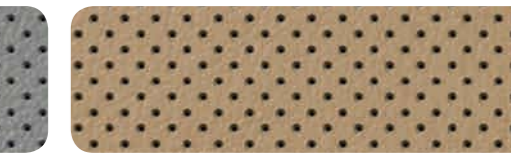

Valcona leather, velvet beige with round perforations

I Valcona leather

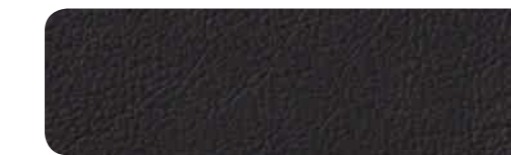

Valcona leather, black



Valcona leather, nougat brown with square perforations and diamond-patterned stitching



Valcona leather, titanium grey with square perforations and diamond-patterned stitching



Valcona leather, velvet beige with square perforations and diamond-patterned stitching



Valcona leather, black with round perforations



Valcona leather, nutmeg

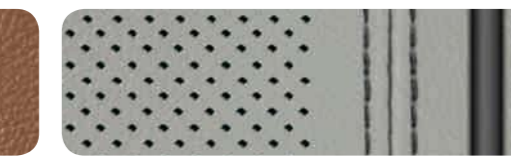

Valcona leather, lunar silver/steel grey with square perforations and diamond-patterned stitching. Only available for the S8



Valcona leather, Atlas beige



Valcona leather, black with square perforations and diamond-patterned stitching

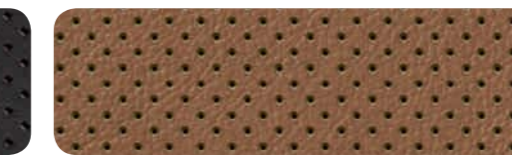

Valcona leather, nutmeg with round perforations



Valcona leather, Atlas beige with round perforations

Fixated on quality.

With Audi seats, you can rely not only on elegant materials and top-class workmanship, but on comprehensive testing procedures as well. Audi tests the quality of all seat leather in its own laboratory, for instance. 45 tests are used to determine durability alone. Clamped in automatic jigs, the leather samples have to show how evenly they stretch, where they start to tear and when they start to develop folds, how abrasion proof and flame resistant they are. Only leather that passes all the tests with flying colours is used for Audi seats.

| Leather packages



Leather package

centre console including knee pad, door armrest upholstery and steering wheel airbag cover in leather with stitching



Extended leather package

in addition to the contents of the leather package, includes: lower door trim including door pockets, underside of instrument panel including glove compartment, and MMI fascia in leather with stitching

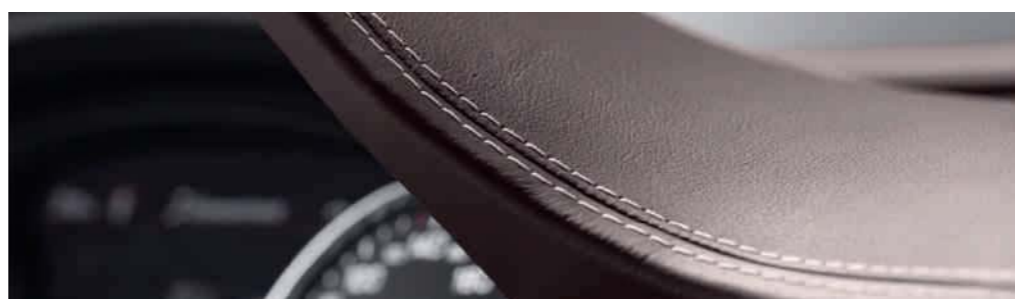

Full-leather package

in addition to the contents of the extended leather package, includes: top side of instrument panel, door rails, front-seat trim and backrest covers, as well as head restraint linings front and rear in leather with stitching; includes headlining and rear parcel shelf in Alcantara, as well as electric sunblinds for the rear window and the rear door windows

Audi exclusive leather upholstery and trim (package 1)*

available in Valcona leather; leather trim for: seats, centre armrest and door trim inserts. Individual choice of colour for the leather, stitching and piping from the Audi exclusive range of colours.

Audi exclusive leather upholstery and trim (package 2)*

available in Valcona leather or Alcantara/Valcona leather; in addition to the contents of package 1, includes: centre console including knee pad, door armrest upholstery in leather. Seat centre panels and door trim inserts available in leather or Alcantara. Individual choice of colour for the leather, Alcantara, stitching and piping from the Audi exclusive range of colours.

Audi exclusive leather upholstery and trim (package 3)*

available in Valcona leather; in addition to the contents of package 2, includes: lower door trim including door pockets, underside of instrument panel including glove compartment and MMI fascia. Individual choice of colour for the leather, stitching and piping from the Audi exclusive range of colours.

Audi exclusive leather upholstery and trim (package 4)*

available in Valcona leather or Alcantara/Valcona leather; in addition to the contents of package 3, includes: top side of instrument panel, door rails, seat trim, head restraint linings front and rear and steering wheel including airbag cover and body in leather; top side of instrument panel available in the following Audi exclusive leather colours: Havana brown, saddle brown, chestnut brown, crimson red, classic red, jet grey, smoky blue, night blue, Iceland green. Individual choice of colour for the leather, Alcantara, stitching and piping from the Audi exclusive range of colours.

| Audi design selection



Valcona leather, Balao brown/snow white with round perforations



Valcona leather, Vermont brown/granite grey with square perforations and diamond-patterned stitching. Only available for the S8



Valcona leather, sycamore grey/brass gold with round perforations

| Natural leather

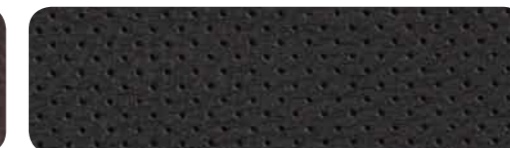

Natural leather, black with round perforations



Natural leather, nougat brown with round perforations



Natural leather, velvet beige with round perforations

| Unicum leather



Unicum leather, nutmeg with square perforations and diamond-patterned stitching

| Audi exclusive



Audi exclusive leather upholstery and trim* Individual choice of colour for leather/stitching/piping. An extract from the range of Audi exclusive leathers can be found from page 64 onwards.

| Seat upholstery

Valcona leather

high-quality leather which contributes to the elegant charisma of the interior. The low use of lacquer allows the material to breathe whilst the non-grained surface underlines the sophisticated character. Tanned without the use of chromium, dyed through and treated with non-fading colour pigments.

Natural leather

The natural characteristics of the leather and an excellent seating climate impart a luxurious character. Low use of lacquer and a non-grained surface. Over time, characteristic signs of use create a typical patina. Tanned without the use of chromium, dyed through and treated with non-fading colour pigments.

Unicum leather

Unicum leather is an exclusive natural leather. The leather is tanned using only plant extracts, is completely dyed through, is not coated with lacquer and yet is water- and dirt-repellent. The new combination of tanning agents creates a special microclimate that ensures exceptional moisture control. This method enables the natural characteristics of the leather to be shown off to their best advantage, the result being excellent breathability, softness and an incomparable natural feel. The typical natural features of the leather and any surface irregularities are also allowed to come through. A very special aura is created thanks to the agreeable feeling of warmth, the exquisite classic leather aroma and the natural feel of the material. Over time, characteristic signs of use create a typical patina.

| Seat variants

- 1 Standard seats, front
- 2 Comfort seats, front
- 3 Comfort seats, front with seat ventilation
- 4 Comfort sport seats, front
- 5 Comfort sport seats, front with seat ventilation

*From quattro GmbH.

The model-specific standard and optional equipment can be found in the index from page 102 onwards.

| **Headlinings**

Headlining and rear parcel shelf in Alcantara
in black, lunar silver, Atlas beige or silk beige to match the selected interior colour; headlining, upper pillar trim, sun visors and rear parcel shelf in Alcantara. Interior colours velvet beige and titanium grey come with matching rear parcel shelf.

Audi exclusive headlining in Alcantara¹
headlining, pillar trims, sun visors and headlining roof panel in Alcantara. Available in all Audi exclusive Alcantara colours. Grab handles, coat hooks and light unit are colour coordinated.

Audi exclusive rear parcel shelf in Alcantara²
available in all Audi exclusive Alcantara colours

| **Seating comfort**

Seat heating, front
heats the seat and backrest centre panel, seat and backrest side bolsters, as well as thigh support; can be individually adjusted for the driver and front-passenger seats in 3 stages via a direct selection button on the air-conditioning controls

Seat heating, front and rear
functions as for seat heating, front; also for the outer rear seats, can be regulated separately

Seat ventilation, front
By drawing in air, the system ensures a pleasant seating climate can be enjoyed even in high temperatures; seat ventilation for the seat and backrest centre panels, the seat and backrest side bolsters as well as the thigh support for the driver and front-passenger seats (can be adjusted in 3 stages); automatic seat heating to prevent cold seats

Seat ventilation, front and rear
functions same as for seat ventilation, front plus ventilation for the seat and backrest centre panels of the outer rear seats

Massage function, front
massages the muscles of the driver and front passenger using 10 pneumatic cushions; 5 different programs (Wave, Tapping, Stretch, Back, Shoulder) and 5 levels of intensity can be selected via multifunction switches on the seat; display in MMI

Massage function, front and rear
same functions as massage function for the front seats, plus, for the outer rear seats, a choice of 2 different programs (Wave, Tapping) and 3 levels of intensity; relaxation seats have a choice of 4 different programs (Wave, Tapping, Stretch, Back) and 5 levels of intensity; can be selected from the centre armrest in the rear



Comfort centre armrest, front
with fold-open storage compartments; divided for driver and front passenger; infinite vertical/horizontal adjustment

Memory function for standard seats, front
memory function for driver and front-passenger seat, steering wheel, both exterior mirrors, head restraint height and seat belt height at front; includes electric adjustment of the front head restraint and belt height

| **Rear seats**

Comfort head restraints, rear
Manually adjustable side bolsters provide enhanced comfort and good lateral support

Footrests, rear
for comfortable travel in the rear; available in pairs

Audi exclusive rear footrests¹
colour-coordinated with the Audi exclusive carpet

Rear seat package in sport seat look¹
electrically adjustable rear bench seat combined with comfort sport seat look



Rear seat system
3 seats, with fold-out centre armrest including 2 cup holders and one storage compartment. (The image shows rear seat system in conjunction with comfort seats, front.)



Individual seat package, rear
· 3-seater rear seat system with 2 electrically adjustable individual seats
· adjustment of fore/aft position, seat and upper backrest angle
· pneumatic lumbar support
· memory function for the individual seats
· comfort head restraints, rear
· 4-zone deluxe automatic air conditioning²
· comfort centre armrest, rear, with wood or carbon trim and controls
· electric sunblinds for the rear window and rear door windows
· fore/aft position of front-passenger seat electrically adjustable from the rear
(The image shows individual seat package, rear in conjunction with comfort seats, front.)

¹From quattro GmbH. ²For A8 hybrid and A8 L hybrid with 3-zone deluxe automatic air conditioning.



Individual seat package, rear with full-length leather-covered centre console
2 individual seats in rear, electrically adjustable; includes the following features in addition to the contents of the individual seat package, rear:
· full-length leather-covered centre console with armrest, wood trim, controls and 230V socket, leather package and ambient lighting
· seat ventilation and massage function, front and rear
· additional storage possibilities in the centre console
(The image shows individual seat package, rear with full length leather-covered centre console in conjunction with comfort sport seats, front, Audi exclusive leather upholstery and trim (see page 64 onwards) and the optional Rear Seat Entertainment)



Relaxation seat package, rear with full-length leather-covered centre console
2 individual seats in rear, electrically adjustable; Same as the individual seat package, rear with full-length leather-covered centre console but with the following additional features:
· luxurious relaxation seat behind the front-passenger seat with footrest on the back of the front-passenger seat backrest
· pneumatic massage as well as seat ventilation and seat heating front and rear
· extending table in the centre console
· Rear Seat Entertainment
(The image shows the relaxation seat package, rear with full-length leather-covered centre console in conjunction with comfort seats, front.)
Please note: Front-passenger seat available only with restricted functions: without adjustable upper backrest, head restraint height, lumbar support, seat and backrest side bolsters; seat ventilation only for the seat cushion, massage function not available

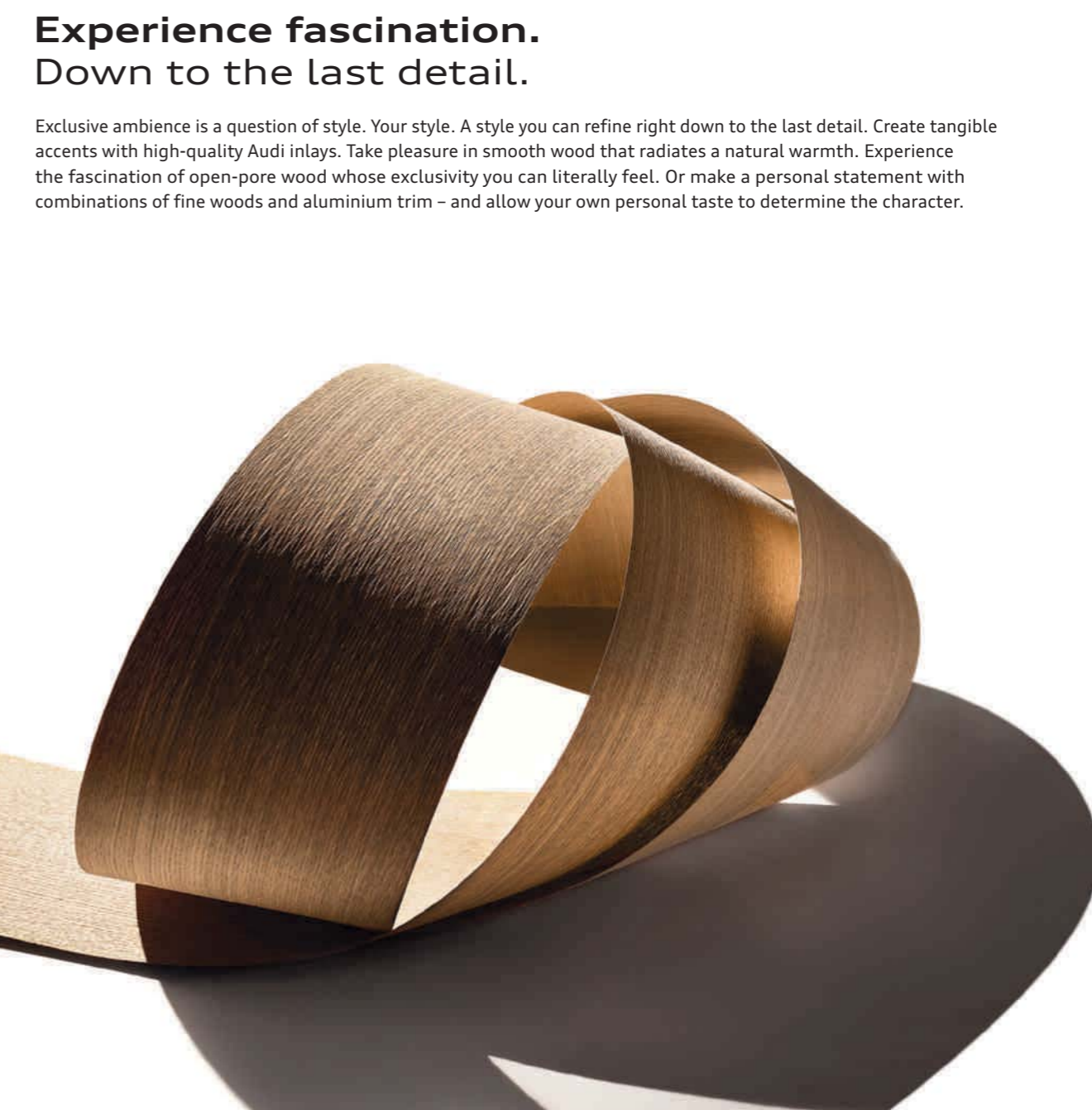

Experience fascination. Down to the last detail.

Exclusive ambience is a question of style. Your style. A style you can refine right down to the last detail. Create tangible accents with high-quality Audi inlays. Take pleasure in smooth wood that radiates a natural warmth. Experience the fascination of open-pore wood whose exclusivity you can literally feel. Or make a personal statement with combinations of fine woods and aluminium trim – and allow your own personal taste to determine the character.

| **Upper inlays**

Walnut, dark brown
choice of lower inlay in high-gloss black or brushed aluminium, silver



Vavona, Assam grey
choice of lower inlay in high-gloss black or brushed aluminium, silver

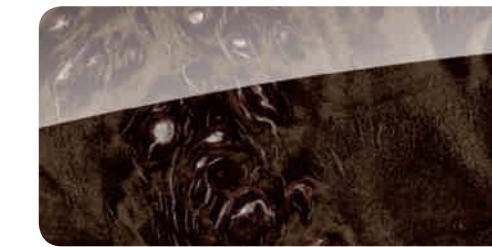

Poplar, brown silver
choice of lower inlay in high-gloss black or brushed aluminium, silver

A fine finishing touch.

Not just any wood is allowed to adorn the interior of your Audi. The fine veneers for the inlays are stripped from the trunks and so-called root burls. Normally, a set of veneers for one car comes from just one burl or trunk to minimise variation. The production process utilises both state-of-the-art machines and the oldest tool in the world – the human hand – with some parts being crafted and polished manually to give them a unique feel.



Upper inlay in walnut, dark brown
Lower inlay in brushed aluminium, silver
Aluminium-look interior



Upper inlay in walnut, dark brown
Lower inlay in brushed aluminium, silver
Extended aluminium-look interior



Upper inlay in walnut, dark brown
Lower inlay in high-gloss black
Aluminium-look interior



Upper inlay in walnut, dark brown
Lower inlay in high-gloss black
Extended aluminium-look interior

Aluminium-look interior
aluminium-look elements on vent surrounds and thumbwheels, MMI display fascia, operating switch for electromechanical parking brake and console for window controls

Extended aluminium-look interior
in addition to the aluminium look in the interior: aluminium-look elements on openers of the fold-open compartments in the door armrests and aluminium switches integrated into the lower inlay. Loading sill protector in stainless steel

Upper inlay
high-quality wood, piano finish, black, or carbon inlays add exclusive touches to the dashboard, door trim and centre console

Lower inlay
inlays in high-gloss black or brushed aluminium, silver on the dashboard and door trims create an impressive contrast

Audi exclusive inlays*
An extract from the range of Audi exclusive inlays can be found on page 65.



Grab handles with wooden segments
matched to the selected inlay; available for inlays in walnut, dark brown, vavona, Assam grey, poplar, brown silver and piano finish, black

Audi exclusive grab handles with wooden segments*
coordinated with the selected Audi exclusive inlay



Fine grain ash, natural brown gold
choice of lower inlay in high-gloss black or brushed aluminium, silver

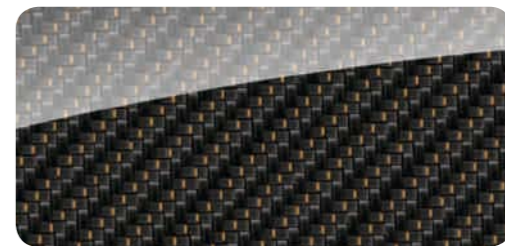

Carbon red
only available with lower inlay in brushed aluminium, silver.
Only available for the S8 with Audi design selection



Fine grain birch, pearl beige*
choice of lower inlay in high-gloss black or brushed aluminium, silver



High-gloss black

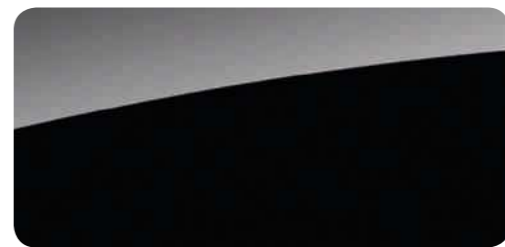

Piano finish, black
choice of lower inlay in high-gloss black or brushed aluminium, silver



Fine grain ash, natural balsamic brown
only available with lower inlay in brushed aluminium, silver.
Only available for Audi design selection



Fine grain ash, velvet brown*
choice of lower inlay in high-gloss black or brushed aluminium, silver



Brushed aluminium, silver

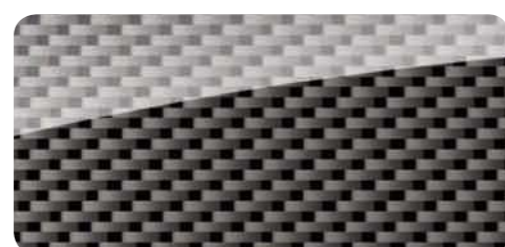

Carbon Atlas
choice of lower inlay in high-gloss black or brushed aluminium, silver
Only available for the S8



Fine grain ash, natural pearl grey
only available with lower inlay in brushed aluminium, silver.
Only available for Audi design selection

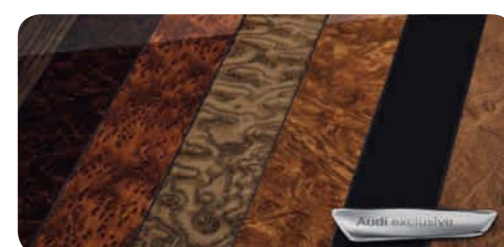

Audi exclusive inlays*
An extract from the range of Audi exclusive inlays can be found on page 65.

*From quattro GmbH.

| Headlights



Xenon plus

intensive illumination of the road, good uniformity and range, both close up and in the distance thanks to headlights utilising durable gas discharge technology for dipped and high beam. Automatic-dynamic headlight range control prevents oncoming traffic from being dazzled. LED daytime running light strip, all-weather light and headlight cleaning system are integrated into the system.



LED headlights

allow precise, near-daylight illumination of the road. Combines LED dipped beam, high beam, daytime running lights, indicators and static turning light as well as an all-weather light to reduce the risk of the driver being dazzled when visibility is poor; includes headlight cleaning system and high-beam assist; striking light pattern with day and night design configurations; low energy consumption and long service life

The model-specific standard and optional equipment can be found in the index from page 102 onwards.



Audi Matrix LED headlights

This innovative technology combines a camera system with LED light sources for adaptive light distribution control. If other road users are detected, the system selectively dims just the area of light falling in front of these vehicles but remains on high-beam in the other areas. Maximum illumination is therefore available at all times, within system limits. The main light functions performed when the vehicle is unlocked (coming home/ leaving home function), when the driving lights are activated and when the respective light distribution patterns are switched, as well as the control process when oncoming traffic passes by, are visible in the headlight as dynamic processes and are tailored to provide the driver with optimum lighting comfort and convenience. The conventional division between dipped and high beam, therefore, is virtually dispensed with. The familiar convenience functions such as the static turning light, all-weather light, dynamic cornering light, variable headlight range control and high-beam assist, junction light, motorway light and travel mode are integrated into the LED technology. They allow near-daylight illumination of the road with minimum energy requirements, a long service life and excellent recognition by other road users thanks to the crisp Audi lighting pattern with day and night design configurations. The daytime running lights and dynamic indicators are implemented in the same light guide and together create the striking Audi lighting signature. Includes headlight cleaning system. The lighting assistant's convenience functions are supplemented by the travel mode, with GPS-assisted switching between left- and right-hand drive modes, and the marking light which, in conjunction with the night vision assistant, illuminates detected pedestrians.



LED rear lights

brake lights, tail lights, indicators and rear number plate lights in low-energy LED technology. Faster activation of the brake lights facilitates earlier recognition by the driver behind. Also included are 2 rear fog lights, reversing lights in white and a 3rd high-mounted brake light in the rear window

LED rear lights with dynamic indicators

same functions as the LED rear lights, but additionally feature a dynamic and quickly recognisable lighting pattern for the indicators. The segments of the LED light band are illuminated in turn within milliseconds, creating a pulse of light that runs outwards in the direction in which the car is turning. When operated, the indicators send a distinctive, innovative signal to other road users

| Interior lighting



Ambient lighting

anti-glare background lighting during the journey, passenger compartment lighting in LED technology; consisting of a light band in the roof module, lighting for door pockets, footwells, rear and door sill trims; surround lighting for centre console (floating effect); brightness can be adjusted in 4 zones, each with 20 dimming stages; choice of 3 colour moods can be selected in the MMI

Interior and exterior lighting package

interior lighting with glove compartment lighting; reading lights in the roof module, footwell lighting, front, inside door handles, vanity lights, light bands at the sides in the headlining, side-mounted reading lights in the rear and luggage compartment lighting in LED technology; exterior lighting with courtesy lighting on the underside of the door handles and handle recess lighting in LED technology



Additional reading lights in the rear

2 additional LED reading lights integrated into the vehicle headlining



Vanity mirrors and additional reading lights in the rear

2 additional LED reading lights integrated into the vehicle headlining and 2 illuminated vanity mirrors

*From quattro GmbH.



Audi exclusive cardan reading lights in the rear*

2 additional swivelling reading lights with LED technology, integrated into the vehicle headlining. Cone of light from reading lamps can be manually adjusted

| Interior design



Door sill trims with aluminium inlays

with illuminated quattro logo in combination with ambient lighting; with model-specific illuminated logo for the A8 hybrid, A8 L hybrid, S8 and A8 L W12



Audi exclusive personalised door sill trims, front and rear*

The aluminium inlay on the front and rear door sill trims can be personalised with a logo.

Audi exclusive floor mats*

Individual choice of colour for the floor mats, the leather piping and the stitching from the range of Audi exclusive colours.

Audi exclusive carpet and floor mats*

Individual choice of colour for the carpet, the floor mats, the leather piping and the stitching from the range of Audi exclusive colours.

| Steering wheels/controls



Multifunction leather steering wheel in 4-spoke design with shift paddles
for operation of installed infotainment equipment; electrically adjustable in height and reach, with full-size airbag; shift paddles for manual gear changing; colour-coordinated with the selected colour for the top side of the dashboard

Multifunction leather steering wheel in 4-spoke design with shift paddles, heated
same functions as multifunction leather steering wheel in 4-spoke design with shift paddles but steering wheel rim additionally heated



Multifunction sport leather steering wheel in 3-spoke design with shift paddles
for operation of installed infotainment equipment; electrically adjustable in height and reach, with full-size airbag; shift paddles for manual gear changing; colour-coordinated with the selected colour for the top side of the dashboard

Multifunction sport leather steering wheel in 3-spoke design with shift paddles, heated
same functions as multifunction sport leather steering wheel in 3-spoke design with shift paddles but steering wheel rim additionally heated



Selector lever in leather
colour-coordinated with the selected vehicle interior colour and to match the top side of the dashboard; with shift-by-wire technology



Selector lever in wood
matched to the selected inlay; with shift-by-wire technology



Audi exclusive selector lever in wood¹
available in a choice of 6 different Audi exclusive woods (not available in tamo ash, natural dark brown); with shift-by-wire technology



Selector lever in carbon Atlas
with shift-by-wire technology



Steering wheel rim with wooden segments¹
for multifunction leather steering wheel in 4-spoke design with shift paddles; available in walnut, brown, vavona, Assam grey, fine grain ash, velvet brown, as well as fine grain birch, pearl beige

Audi exclusive steering wheel rim with wooden segments¹
for multifunction leather steering wheel in 4-spoke design with shift paddles; customised with Audi exclusive wood and leather; individual choice of various Audi exclusive colours for stitching; specific Audi exclusive seam detail

Audi exclusive leather steering wheel¹
leather for the steering wheel rim and airbag cover available in all Audi exclusive colours; individual choice of colour for stitching in various Audi exclusive colours with specific Audi exclusive seam detail

Audi exclusive leather controls¹
leather for the steering wheel rim, selector lever and airbag cover available in all Audi exclusive colours; individual choice of colour for stitching in various Audi exclusive colours; stitching on the steering wheel rim with specific Audi exclusive seam detail



Slide-and-tilt glass sunroof
electric, with tinted single-glazed safety glass and infinitely adjustable sun screen; wind deflector extends automatically in stages depending on roof opening and speed; convenience closing from outside via the vehicle key



Solar slide-and-tilt glass sunroof
Solar cells in the roof provide the power to generate a continuous flow of air to reduce passenger compartment temperature when the vehicle is parked. Operated like the slide-and-tilt glass sunroof, but has no infinitely adjustable sun shield



Panoramic glass sunroof
2 sections; electric activation to raise and open the front glass section as well as to raise the rear glass section, opens and closes automatically; with tinted glass insert and 2 electrically operated sunblinds as well as convenience closing via the vehicle key; ensures that the interior is flooded with light; good acoustics and low wind noise when the sunroof is extended or fully opened; improves the interior climate by means of efficient ventilation whilst at the same time reducing draughts; vanity mirrors and additional reading lights in the rear. With selected exterior colours², the surrounding roof is painted in black.

| Glazing

**Dark-tinted windows (privacy glazing)**

dark-tinted rear window, rear door windows and rear side windows. Optionally with windscreen heater

Double/acoustic glazing

provides improved exterior noise insulation and theft protection thanks to the 2 panes of glass bonded together by a plastic film

Insulating/acoustic glass

provides improved exterior noise insulation and theft protection thanks to the 2 panes of glass bonded together by a plastic film. An additional reflective coating reduces the build-up of heat in the interior. Viewing window for automatic toll collection devices in the upper right-hand corner, to the side of the interior mirror

Windscreen heater

heats insulating/acoustic glass windscreens. Full surface of windscreen heated without heating wires that might impair visibility, makes rapid defrosting easier and ensures that the windscreen stays mist free; heating is controlled via the deluxe automatic air conditioning

**Sunblinds**

optionally:

electrically operated for the rear window**electrically operated for the rear window and rear door windows**

| Climate control

**Deluxe automatic air conditioning**

separate temperature and air flow control for head area and footwell for both driver and front passenger with indirect ventilation and sunlight-dependent control; air intake control and recirculation mode, residual heat utilisation, combined/fine particulate filter, air quality and humidity sensor and key-coded setting; choice of 3 climates: gentle, medium and intensive

**3-zone deluxe automatic air conditioning**

in addition to deluxe automatic air conditioning: air-conditioning controls for rear-compartment climate control in the rear centre armrest with separately adjustable temperature and blower settings and air distribution; rear-compartment A/C functions can also be adjusted from the air-conditioning controls in the front

**4-zone deluxe automatic air conditioning**

greater comfort for the rear passengers and enhanced heating and cooling performance through the use of a second air-conditioning unit; same as deluxe automatic air conditioning but with the following additional features: air conditioning controls for rear-compartment climate control in the rear centre armrest with separately adjustable temperature and blower settings and air distribution for the right- and left-hand sides

**Auxiliary heating/ventilation**

The auxiliary heating warms up the interior and removes ice from the windows without starting the engine. The auxiliary ventilation system supplies fresh air and reduces the temperature of the interior. Intelligent control function with timer and departure time programming for time- and energy-efficient calculation of heating duration. Separate radio-operated remote control with illuminated display

Ioniser

can help to improve wellbeing and attentiveness. Ionisation reduces harmful particles and germs in the air, thus improving the air quality in the vehicle interior. Activation by means of a button on the right-hand B-pillar

Lights Design Steering wheels/controls Comfort Infotainment Assistance systems Technology/safety Audi Extended Warranty

| Closing systems

Power-assisted door closing

automatically pulls doors that are not completely closed into the lock; includes electric child-proof locks on the rear doors

Remote control key

unlocks and locks doors, luggage compartment lid and tank flap; includes keyless go function and convenient closing/opening of the windows

Luggage compartment lid, electrically opening and closing

opening via button on the vehicle key or in the driver's door or via the soft touch button in the luggage compartment lid handle; additionally by means of foot gesture (kicking motion) if convenience key with sensor-controlled release of luggage compartment lid is ordered; closing via button on the inside of the luggage compartment lid, the button in the driver's door or the convenience key (long press). In conjunction with the convenience key, it is possible to close the luggage compartment lid and simultaneously lock the car via an additional button on the inside of the luggage compartment lid. Includes power-assisted closing

**Convenience key with sensor-controlled release of the luggage compartment lid**

Doors and luggage compartment lid can be unlocked and locked without actuating the vehicle key you are carrying with you; doors are unlocked automatically by touching the door handles, the luggage compartment by operating the handle strip on the luggage compartment lid. Moving your foot (in a kicking motion) below the rear bumper causes the luggage compartment lid to swing open automatically. The luggage compartment lid can also be opened separately when the vehicle is locked

Garage door opener (HomeLink)

programmable radio-operated remote control with operating buttons integrated into the front roof module; can be used to open many garage doors and exterior gates; allows control of security systems and lighting systems; code identification guidance and set-up assistance provided by the MMI. For further information please contact your Audi partner or visit www.eurohomelink.com.

Anti-theft alarm

monitors doors, bonnet and luggage compartment lid; includes interior monitoring (can be deactivated), tow-away protection via a vehicle angle of inclination sensor and signal horns independent of the vehicle electrical system; with safe-locking function: prevents the doors from being opened from the inside once the vehicle has been locked with the vehicle key

| Storage Transport

**Through-loading facility**

enables extended loading possibility for the practical transportation of long objects

**Through-loading facility with removable ski/snowboard bag**

for the practical transportation of long objects, e.g. up to 2 pairs of skis or 1 snowboard

| Storage Transport



Audi exclusive coolbox¹
storage compartment for two 1 litre bottles lying down and additional storage compartment for cans and glasses; with compressor cooling technology and 2 possible temperature settings: -6 °C freeze, +6 °C cool; interior LED lighting



Audi exclusive bar compartment¹
additional storage compartment for 2 glasses, integrated into the full-length centre console.



230V/115V/100V socket
for direct operation of electrical consumers such as power adapters for laptops, mobile phones, games consoles or other AC equipment with a power output of up to 150 watts; works when the ignition is switched on; replaces 12V socket/cigarette lighter in rear

Audi exclusive storage compartment¹
additional lockable storage compartment, integrated into the full-length centre console.

Non-smoker package
Omission of ashtray in the front centre console

Cigarette lighter and ashtray
illuminated, front and rear



Audi exclusive foldaway table¹
with fine wood inlay, on the back of the driver's and/or front-passenger seat backrest; operated manually

Personalisation of the Audi exclusive foldaway table¹
customisation of the fine wood folding table with lettering, a logo or a coat of arms. The feature is visible when the table is closed and folded out.

Lights Design Steering wheels/controls Comfort Infotainment Assistance systems Technology/safety Audi Extended Warranty

| MMI®/navigation



A8 hybrid luggage set
customised for the A8 hybrid and A8 L hybrid luggage compartment. Set comprises 2 suitcase trolleys (each 63 l) and 2 cabin trolleys (each 40 l) featuring polycarbonate shells with nylon fabric and telescopic handles, smooth running wheels and handle application made of cowhide; 1 shoe bag (20 l) made from grey nylon fabric for holding up to 2 pairs of shoes

Luggage compartment package
for flexibility and convenience when transporting items and travelling; comprises a luggage net for securing to the lashing points on the luggage compartment floor, 2 fold-out bag hooks integrated into the top of the luggage compartment, a 12V socket on the side wall and an umbrella holder on the inside of the luggage compartment lid

Trailer towing hitch
electrically swivelling, ball head and ball joint coupling made from special steel; operated via buttons in the luggage compartment; includes trailer stabilisation system via the Electronic Stabilisation Control (ESC) The integrated swivelling system socket enables continuous operation of electrical equipment in the trailer or caravan during a journey.



Driver information system with colour display
displays a host of useful information on a high-resolution 7-inch colour display in the instrument cluster. Attention assist warns the driver, in the form of an acoustic signal and a visual warning, if it has evaluated that the driver's attention is lapsing. Integrated efficiency program provides assistance in the form of fuel consumption summaries. A8 hybrid and A8 L hybrid models have an additional display of the flow of energy

MMI®
integrated operating concept consisting of MMI terminal as the control unit and MMI display for showing various menus. The high-resolution 8-inch colour display in high-quality piano finish look is retractable. 6 freely programmable radio station presets enable fast retrieval

MMI® touch
context-related entry of letters, characters and numbers on touch-sensitive control panel with handwriting recognition for intuitive operation of the MMI; selection from address book and entry of navigation destinations or phone numbers with acoustic acknowledgement allows drivers to keep their eyes on the road; simple movement of navigation map, selection of points of interests and retrieval of 6 freely programmable radio stations; part of MMI navigation plus



MMI® navigation plus with MMI touch

- hard drive navigation² with topographical map display and display of many places of interest and city models in 3D.
- choice of 3 alternative routes, scrolling along the route and manoeuvring within the map
- dynamic route guidance with TMCpro and read-aloud function for traffic messages
- route information displayed in split-screen format. Detailed intersection map, motorway exits and lane recommendations also in driver information system
- vehicle support based on navigation data and speed limit display
- intuitive operation via MMI touch with handwriting recognition for entry of letters and numbers; can be controlled without the need for drivers to divert their eyes from the road
- voice control system enables operation by means of whole-word entry of address in one sentence
- Bluetooth interface, 20 GB music storage and Audi music interface
- use of services supported by Audi connect³

The display in A8 hybrid and A8 L hybrid models features an additional display of the energy flow and the consumption diagram

Powermeter in the instrument cluster
for displaying the operating modes in the A8 hybrid and A8 L hybrid (pure electric driving, driving with combustion engine only, recuperation, coasting, boost) as well as the availability of the hybrid system

| Entertainment

MMI® radio plus

can be operated via MMI; equipped with triple tuner with phase diversity for improved sound and reception; dynamic station list and TP memo function (automatic storage of traffic messages) whilst driving; music and videos played via the single-DVD drive, the 2 SDHC memory card readers and the jukebox with 20 GB storage capacity; each supports audio formats (MP3, WMA and AAC) and video formats (MPEG-1 to MPEG-4, WMV, Xvid) and playlists. Music and video files can be copied to the integrated hard disc. Files with digital rights management (DRM) cannot be played.

Digital Audio Broadcasting

in addition to the range of analogue stations, reception of digitally broadcast radio stations¹ broadcast according to DAB standards, including DAB+ and DMB audio; display of information accompanying the programme (e.g. artist and track, if provided by the radio station) as well as additional information in the form of a slide show (e.g. cover and weather)

Digital TV reception

reception of digitally broadcast (DVB-T), uncoded television stations¹ (MPEG-2 or MPEG-4 standard), DVB-T audio stations, teletext and Electronic Programme Guide (EPG); external AV-IN connection via adapter cable; no picture is possible when the vehicle is moving

Audi music interface

enables connection of portable media players², such as an Apple iPod/iPhone (music functionality) and USB storage media and MP3 players, by means of special adapter cables from Audi Genuine Accessories. In the centre console; operated via MMI or multifunction leather steering wheel; part of MMI navigation plus with MMI touch. In conjunction with the Audi music interface, the separate AUX-IN connection is omitted.

DVD/CD changer

for 6 DVDs or CDs, supports e.g. audio CDs, video DVDs, MP3, WMA, AAC, MPEG-4 and playlists as well as up to 4,000 tracks per medium. Files with digital rights management (DRM) cannot be played. Shock-resistant location in glove compartment. Can be operated via MMI



Audi sound system.

6-channel amplifier with a total output of 180 watts and 10 loudspeakers, including centre speaker and subwoofer



Bose Surround Sound

impressive surround sound reproduction thanks to 12-channel amplifier with total output of over 600 watts and 14 loudspeakers, including centre speaker and subwoofer; AudioPilot® for noise-dependent volume adjustment and 5.1 surround sound reproduction; powerful and accurate bass reproduction thanks to Acoustic Wave loudspeaker technology



Bang & Olufsen Advanced Sound System

captivating surround sound reproduction with 19 loudspeakers, including subwoofer, each with its own amplifier channel. The highly efficient all-digital 5-channel ICE Power amplifier for woofer and subwoofer and the 14-channel DSP all-digital amplifier have a total output of over 1,400 watts. 5.1 surround sound reproduction is possible. Polished loudspeaker covers in aluminium and automatically extending acoustic lenses for excellent sound performance and perspective in any seat; with noise-dependent volume adjustment. Privacy function provided by encapsulated loudspeaker casings which minimise the escape of sound to the outside of the vehicle and provide privacy, for example when making phone calls.



Rear Seat Entertainment

superb entertainment facility for the rear passengers, with 2 high-resolution adjustable-angle 10.2-inch LCD displays; access to numerous audio and video sources; use of navigation functions; shared or separate video and audio playback for each seat; sound output via the vehicle sound system or separate headphones; includes Audi music interface and MMI control panel in rear

| Communication



Audi connect including car phone

Use of Audi connect and more convenient phoning thanks to integrated car phone. The vehicle is connected to the internet by means of an integrated data module. Import of phone book entries and call list management possible.

The following services supported by Audi connect are available in your model:

Mobility & navigation

- Point-of-interest (POI) search with voice control
- Traffic information online
- Fuel prices
- Parking information
- Country information
- Navigation with Google Earth™³ and Google Street View™³
- Destination entry via myAudi or Google Maps™³

Communication

- Wi-Fi hotspot

Infotainment

- Weather
- Audi music stream
- News online
- City events
- Travel information

Use of the services supported by Audi connect is possible only with the optional MMI navigation plus with MMI touch and Audi connect including car phone. You also require a SIM card with data option – in the case of the car phone, a SIM card with phone and data option – or a Bluetooth-capable smartphone⁴ with remote SIM Access Profile (rSAP). There is a reader for your SIM card in the surround of the MMI navigation plus with MMI touch. The services are available only in conjunction with an existing or separate mobile phone contract and only within the range of the respective the mobile phone network. Additional costs may be incurred when receiving data packets from the internet, depending on the terms of your mobile phone contract, particularly when used abroad. Because of the high data volumes involved, a data flat rate is strongly recommended. The availability of the services supported by Audi connect varies from country to country. The services are provided for at least one year from vehicle delivery. 24 months after vehicle delivery, the Audi connect services will be extended free of charge once for 12 months. Ask your Audi partner about a subsequent extension of the Audi connect services.

Please visit www.audi.com/connect or contact your Audi partner for more detailed information about Audi connect; contact your mobile services provider for information about contract conditions.

| Communication



Audi phone box¹
allows phone calls to be made in the vehicle by placing the mobile phone in the universal mobile phone holder in the front centre armrest; includes a hands-free facility and voice control for the telephone functions; includes an integrated coupling aerial for connection of the mobile phone with the external aerial, thus reducing radiation inside the vehicle and improving signal quality; operation via the MMI, multifunction leather steering wheel or voice control system; can be charged via USB port

Bluetooth interface

enables hands-free calls in the vehicle via the micro-phone and Bluetooth audio streaming² (depending on mobile phone compatibility). Bluetooth-capable mobile phones can be connected to the vehicle via the interface which is part of the MMI navigation plus with MMI touch



Handset in the front for car phone
for making private phone calls; easy writing of text messages thanks to automatic word recognition; cordless handset with colour display and integrated SIM card reader housed in the front centre armrest

Handsets in the front and rear for car phone

in addition to the handset in the front for car phone, a further cordless handset with colour display and integrated SIM card reader is provided; located respectively in the front centre armrest and the rear centre armrest

| Assistance systems



Parking system plus³
acoustic and visual parking system for the front and rear; provides assistance when parking and manoeuvring. Information shown in the MMI display; measurement by ultrasonic sensors concealed in the bumpers; activated when reverse gear is selected or via button on the centre console



Reversing camera³
image of area behind the vehicle shown on the MMI display, with dynamic display modes showing the calculated path (steering angle dependent); includes auxiliary lines and guidelines and identification of the point at which to apply opposite lock when parallel parking, reversing camera integrated discreetly in the handle strip of the luggage compartment lid; activated when reverse gear is selected or via button on the centre console



Park assist with display of surroundings³
uses ultrasonic sensors to search for suitable parking spaces along the side of the road and helps the driver to park and exit a parking space by performing autonomous steering manoeuvres. Calculates the ideal parking path for bay parking spaces and the ideal parking and exiting paths for kerb-side parking spaces. The driver has to accelerate, apply the brakes and monitor the parking process. The display of the surroundings warns the driver of any obstacles at the side of the vehicle, depending on the steering angle. Also additionally available with reversing camera or 360 degree cameras; activated via button on the centre console

Cruise control³

Between speeds of around 30 km/h and 250 km/h, the system maintains the desired speed provided engine power output and engine braking effect permit; automatic braking function, e.g. when driving downhill; operated via separate steering column stalk. Set speed displayed in the driver information system

Audi pre sense basic³

automatically initiates preventive passenger protection measures when required; these include: belt tensioning, activation of the hazard warning lights and closing of sunroof and windows; categorises different driving situations through the networking of the various vehicle systems



360 degree cameras³
safe pulling out of narrow parking spaces. Various display options for the area around the vehicle, including a virtual top view, can be selected on the MMI display. The driver can select between different image views in the MMI display: reversing image, front camera image, front and rear side view and bird's eye view. Includes the features of the reversing camera; activated when reverse gear is selected or via button on the centre console

**Head-up display**

Information relevant to the driver from assistance systems, navigation instructions and warnings is projected as required onto the windscreen in the driver's direct field of vision. The height-adjustable head-up display provides a multicoloured display with good contrast and minimal distraction from the road.



adaptive cruise control with Stop&Go function including Audi pre sense front³
detects vehicles ahead with the aid of radar sensors. The distance from the vehicle ahead is kept more or less constant by braking or accelerating (control range 0–250 km/h). Braking to a stop and automatic restart at driver's request are possible. Choice of 4 distance levels/driving modes (efficiency, comfort, dynamic and auto). Includes Audi pre sense front: enhanced brake assist function warns the driver of an imminent risk of a collision with the vehicle ahead. Can initiate partial braking if required or increase the level of braking already being provided by the driver. In addition, maximum braking is initiated at speeds below 30 km/h if there is a danger of collision with a stationary or moving vehicle in order to reduce the speed of the collision or to avoid the collision if possible. adaptive cruise control is operated via separate steering column stalk; Audi pre sense front can be deactivated via the MMI Car menu



Audi side assist including Audi pre sense rear³
emits a warning in the form of an LED display in the respective exterior mirror if a situation arises which the system deems will compromise a lane change. 2 radar sensors record the vehicle approaching at the side from behind and measure the distance and the difference in speed. The lane change assistant provides support in the speed range from about 30 to 250 km/h. To detect a possible rear-end collision, Audi pre sense rear also uses the rear sensors of Audi side assist, in addition to Audi pre sense basic. Activated via button in the mirror quadrant

**Audi active lane assist³**

helps to keep you in lane by applying gentle corrective steering movements. Audi lane assist is activated if the car starts to cross detected road markings and the driver has not operated an indicator. The system provides assistance in the speed range from about 60 km/h to 250 km/h. Steering wheel vibration can be adjusted if the driver wants; activated via button on the indicator steering column stalk



Night vision assistant³
assists the driver when driving at night by displaying a thermal image of the surroundings. Persons and larger wild animals are highlighted in yellow in the driver information system. If they move or if the system determines from their position that there is a potential risk, the highlighting changes to red, a warning triangle appears and a warning tone is emitted.

In conjunction with one of the following lighting systems, a highlighted person is also illuminated with 3 successive brief flashes of the headlights (marking light):

- LED headlights
- Audi Matrix LED headlights

Additional display of warning messages in the optional head-up display. Activated via button next to the light switch

| Assistance systems



Camera-based speed limit display¹

recognition and display of speed limits, including temporary speed limit displays; a situational evaluation is carried out when driving in the wet, when there are speed limits for certain times of day, or when towing a trailer²; if a sign has not been recognised by the camera, the speed limit taken from the current navigation data (if available) is displayed via Audi connect; displayed automatically in the driver information system, additional display in the optional head-up display. The system has purely informative character, there is no intervention and no warning if the displayed speed is exceeded.

Assistance package including Audi pre sense plus¹

combines the following assistance systems:

- Parking system plus
- Audi active lane assist
- Audi side assist
- adaptive cruise control with Stop&Go function
- Audi pre sense front
- Audi pre sense rear

In addition, the last functions are supplemented by a maximum deceleration function provided by Audi pre sense plus. The systems in the assistance package complement each other and provide mutual assistance. Details of how to activate or adjust assistance systems can be found in the relevant system description.

| Driving dynamics/brakes

Audi drive select

Different modes – comfort, dynamic, auto, efficiency (not for A8 hybrid and A8 L hybrid) and individual – allow you to change the vehicle's characteristics, for example by adapting the power steering assistance, engine and gear changing characteristics and the adaptive air suspension. In addition, the system can influence the settings of other optional equipment and in efficiency mode shifts the engine, transmission, adaptive cruise control (optional) and climate control to a more fuel-efficient basic setting.

adaptive air suspension

automatically regulates the vehicle height and damping by means of the electronically controlled air suspension with infinitely variable adaptive damping system on all 4 wheels; includes ride height control and manual lift function; various modes can be selected via Audi drive select

adaptive air suspension – sport

The sport suspension based on the standard adaptive air suspension has stiffer damping. Compared to adaptive air suspension, the vehicle ride height is lowered by up to 10 mm, depending on mode.

quattro®

permanent all-wheel drive with self-locking centre differential and asymmetric/dynamic torque distribution, as well as wheel-selective torque control and Electronic Differential Lock (EDL) on all driven wheels; quattro emblem in Audi Singleframe (only for A8 and A8 L), on the luggage compartment lid and in the dashboard on the passenger side

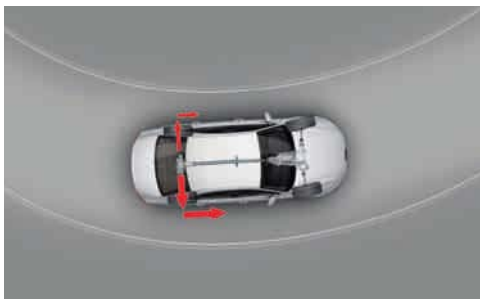

quattro® with sport differential

The electronically controlled sport differential distributes variable amounts of drive force to each rear wheel and ensures outstanding acceleration performance in corners and stabilises the vehicle's response to load change. It also improves direct steering characteristics and provides more agile handling due to the lower steering effort required.

tiptronic

8-speed automatic transmission with Dynamic Shift Program (DSP); option of manual control via shift paddles on the multifunction leather steering wheel; includes additional sport program

Electromechanical power steering

combines precision and comfort with exceptional energy-saving technology. The electromechanical steering system with speed-sensitive steering assistance ensures stability at high speeds whilst also being light and precise when parking and manoeuvring. With active countersteering to provide steering assistance to the driver for enhanced vehicle stability



Ceramic brake³

19-inch high-performance brake system with carbon-fibre reinforced ceramic brake discs and brake callipers painted in high-gloss anthracite and featuring the "Audi ceramic" logo at front and rear; ventilated and perforated brake discs with special cooling channels

Secondary collision brake assist

Following an accident, uncontrolled continued vehicle motion is prevented in certain situations. In these cases secondary collisions can be avoided.

Dynamic steering

improves handling and ride comfort by dynamically regulating the steering according to the driving situation, for example when cornering, changing lanes or parking; in addition to adaptation of the steering effort, the steering angle (steering ratio) is also adapted by up to 100 % depending on the steering wheel angle, the speed and the Audi drive select setting. Vehicle stabilisation via ESC is further supported by the system's lightning-quick steering movements.

| Technology/safety

Active Noise Cancellation

can compensate noises from individual frequencies depending on the engine speed

Audi Space Frame (ASF®) body

The lightweight Audi Space Frame is an innovative combination of materials featuring a high degree of rigidity. This provides a high level of safety with an agile driving sensation – and reduced fuel consumption. The body is made almost entirely of aluminium. Because every gram less extends the lead. New, high-strength aluminium alloys are used for panels, castings and profiles and further reduce weight. For the first time, hot-formed steel panels are also integrated into the body structure in order to further improve its function. They are located in the region of the B-pillar.

Start-stop system

helps to reduce fuel consumption and CO₂ emissions by switching off the engine automatically when the vehicle is stationary, e.g. at traffic lights. The start process is initiated as soon as the foot brake is released. Can be deactivated at any time via a button

Lights Design Steering wheels/controls Comfort Infotainment Assistance systems Technology/safety Audi Extended Warranty

Audi cylinder on demand

This technology helps to lower fuel consumption significantly and also reduces CO₂ emissions. If the full power of the engine's 8 or 12 cylinders is not required, for example when operating in the partial-load range or when coasting, 4 or 6 of the cylinders are shut down. On the 4.0 litre V8 TFSI engine, this involves automatically closing the intake and exhaust valves and switching off fuel injection and ignition on 4 of the cylinders. The 6.3 litre W12 FSI engine uses a special variant of the Audi cylinder on demand technology. The system first switches off fuel injection and ignition for all cylinders of the left bank, so that the engine is operating on six cylinders. Before the temperature on this side of the engine and in the associated catalytic converter drops too much, the left bank is fired again, and the right bank is then deactivated. During extended deactivation phases, the two cylinder banks are alternately active and inactive. A display in the driver information system shows which cylinders are active

Audi TDI clean diesel

In addition to the standard equipment with catalytic converter and diesel particulate filter, the exhaust aftertreatment system installed in the models with TDI clean diesel leads to low exhaust emissions and consequently complies with the EU6 emission standard which comes into force in September 2014. This technology significantly reduces nitrogen oxides by injecting small amounts of the biodegradable additive AdBlue®⁴ into the exhaust flow. The nitrogen oxides are then split into nitrogen and water in the nitrogen-oxide catalytic converter (DeNOx catalytic converter). The separate AdBlue tank is refilled as indicated by the information in the display of the instrument cluster. We recommend having the AdBlue tank refilled at your Audi partner.

Audi exclusive seat belts⁵

Individual choice of colour for seat belt from the range of Audi exclusive colours.

ISOFIX child seat mounting and top tether for the outer rear seats

Standard bracket for the practical fastening of ISOFIX child seats; including additional fastening point (top tether).

Recommended child seats are available from your Audi partner.

| Audi Extended Warranty

Audi Extended Warranty

The Audi Extended Warranty provides extended risk cover and cost control beyond the first 2 years of the manufacturer's warranty for a variety of claims. It can be ordered directly and only on purchase of a new car. Choice of 9 service life/total mileage combinations. Ask your Audi partner for more detailed information.

¹ Please note: The systems work only within system limits and assist the driver. However, the driver remains responsible for driving the vehicle and is required to be attentive at all times.

² Only applies to factory-fitted trailer towing hitches. ³ Please consult your Audi partner or national Audi website to find out more about the special features of the ceramic brake.

⁴ Registered trademark of the Verband der Automobilindustrie e.V. (VDA). ⁵ From quattro GmbH

Audi Genuine Accessories. As individual as the life you lead.

An Audi is an expression of your personality. And Audi Genuine Accessories build on this concept in the truest sense of the word, with a range of high-quality products that are coordinated with your Audi. Noted for their perfect fit, safety credentials and functionality, they serve to add even more individuality to your car and to tailor it to your own personal requirements. So that your Audi becomes your own personal Audi. These two pages contain just a small selection from the extensive range of Audi Genuine Accessories on offer.



Detailed information can be obtained from the Audi A8 accessories catalogue, at www.audi.com, and from your Audi partner.

Cast aluminium wheels in 5-arm parabola design

Exceptional design, perfectly matched to your Audi A8. With arms¹ in a gloss turned finish, size 9 J x 20. For tyre size 265/40 R 20².

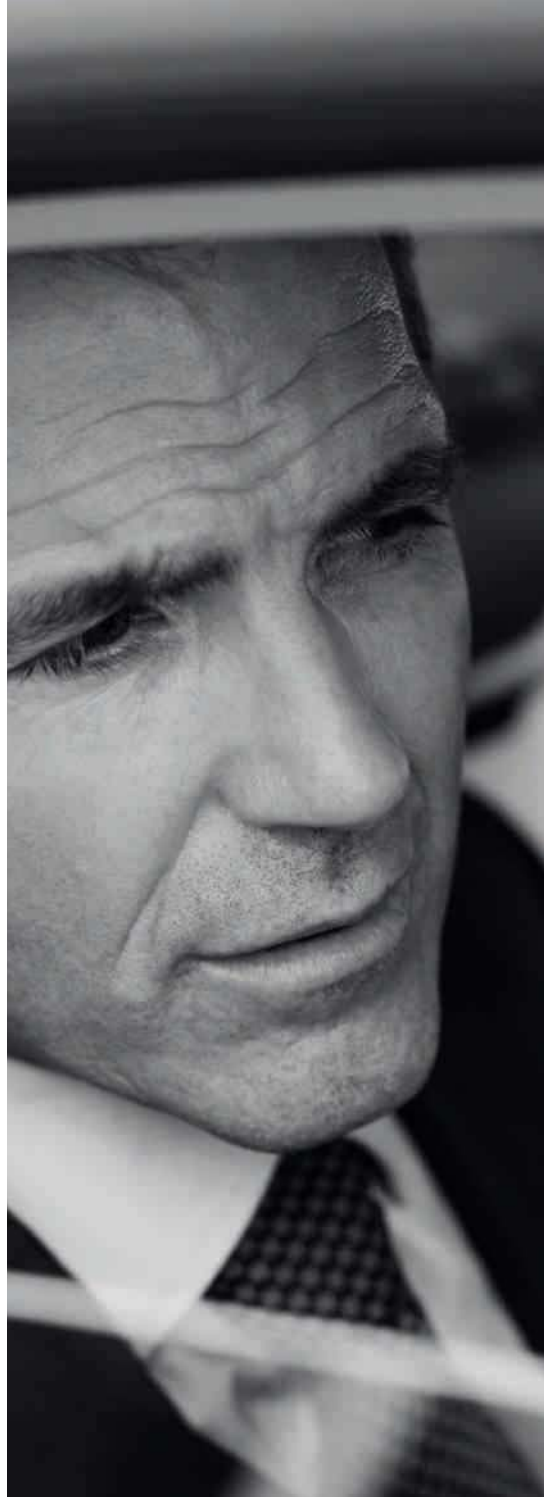

Ski and luggage boxes

New Audi design with improved aerodynamics thanks to flatter, sportier lines; platinum grey roof box with brilliant black side blade and chrome-plated Audi rings; high-quality look with no visible rivets. Lockable and can be opened from both sides for easy loading and unloading. With interior handle for closing the box. Simple quick-release fastening system including torque control. Advanced position allows better access to the luggage compartment. Available in three sizes: 300 l (illustration above), 360 l and 405 l. Maximum permissible load: 75 kg

Adapter cables for Audi music interface³

Enable music and data from various mobile phones and other media players to be transferred to the optionally available Audi music interface. Can be operated via the infotainment system.



Audi child seat youngster plus

Offers superior comfort thanks to intelligent belt guidance. The backrest is adjustable in height and width. Adaptations can be made via a viewing window for size adjustment. Suitable for children from 15 to 36 kg (approximately 4 to 12 years).

Navigation update³

Map data containing upgraded contents, e.g. new roads, points of interest and restaurants. For added convenience and a more relaxed driving experience. We recommend that you combine the update with your next vehicle service.

Audi tracking system plus³

Enables a stolen vehicle to be located and tracked via GPS/GSM technology in 27 European countries. With automatic driver recognition and intelligent restart inhibitor.

¹Please note the special information relating to wheels on page 99. ²You will find specifications on the technical characteristics of tyres on page 99. ³For more detailed information, please contact your Audi partner. The fuel consumption and CO₂ emission figures can be found from page 96 onwards.

Model	A8 3.0 TFSI quattro (228 kW)		A8 4.0 TFSI quattro (320 kW)		A8 3.0 TDI clean diesel quattro (190 kW) ¹¹		A8 4.2 TDI clean diesel quattro (283 kW) ¹¹	
Engine type	V6 petrol engine with direct fuel injection and mechanical supercharger		V8 bi-turbo petrol engine with direct fuel injection, Audi valvelift system and Audi cylinder on demand		V6 diesel engine with common rail injection system and turbocharging		V8 diesel engine with common rail injection system and turbocharging	
Displacement in cc (valves per cylinder)	2,995 (4)		3,993 (4)		2,967 (4)		4,134 (4)	
Max. output ¹ in kW at rpm	228/5,200–6,500		320/5,100–6,000		190/4,000–4,250		283/3,750	
Max. torque in Nm at rpm	440/2,900–4,750		600/1,500–5,000		580/1,750–2,500		850/2,000–2,750	
Power transmission/wheels								
Drive type	quattro® permanent all-wheel drive		quattro® permanent all-wheel drive		quattro® permanent all-wheel drive		quattro® permanent all-wheel drive	
Transmission type	8-speed tiptronic		8-speed tiptronic		8-speed tiptronic		8-speed tiptronic	
Wheels	Forged aluminium wheels, 8 J x 17		Cast aluminium wheels, 8 J x 18		Forged aluminium wheels, 8 J x 17		Cast aluminium wheels, 8 J x 18	
Tyres	235/60 R 17 ²		235/55 R 18 ²		235/60 R 17 ²		235/55 R 18 ²	
Weights/capacities								
	A8	A8 L	A8	A8 L	A8	A8 L	A8	A8 L
Unladen weight ³ in kg	1,905	1,955	1,995	2,050	1,955	2,010	2,115	2,170
Gross vehicle weight in kg	2,520	2,530	2,570	2,625	2,570	2,585	2,705	2,720
Roof load/trailer nose weight in kg	100/95	100/95	100/95	100/95	100/95	100/95	100/95	100/95
Trailer load limit ⁴ in kg unbraked	750	750	750	750	750	750	750	750
12 % gradient	2,300	2,300	2,300	2,300	2,200	2,200	2,300	2,300
8 % gradient	2,300	2,300	2,300	2,300	2,200	2,200	2,300	2,300
Fuel tank capacity, approx. in l	82	82	82	82	82	82	82	82
Performance/consumption⁵								
Top speed in km/h	250 ⁶	250 ⁶	250 ⁶	250 ⁶	250 ⁶	250 ⁶	250 ⁶	250 ⁶
Acceleration 0–100 km/h in s	5.7	5.9	4.5	4.6	5.9	6.1	4.7	4.9
Fuel grade	Sulphur-free super RON 95 ⁷		Sulphur-free super plus RON 98 ⁸		Sulphur-free diesel ⁹		Sulphur-free diesel ⁹	
Fuel consumption ¹⁰ in l/100 km								
urban	10.5	10.6	12.6	12.8	7.3	7.5	9.4	9.5
extra-urban	6.3	6.3	7.1	7.2	5.1	5.2	6.1	6.2
combined	7.8	7.9	9.1	9.2	5.9	6.0	7.4	7.5
CO ₂ emissions ¹⁰ in g/km								
urban	245	246	294	299	192	196	247	249
extra-urban	147	148	166	169	134	136	161	163
combined	183	184	213	216	155	158	194	197
Emission standard	EU6	EU6	EU6	EU6	EU6	EU6	EU6	EU6

Explanatory notes ¹ to ¹² on page 99.

Model	A8 L W12 6.3 FSI quattro (368 kW)	S8 4.0 TFSI quattro (382 kW)
Engine type	W12 petrol engine with direct fuel injection and Audi cylinder on demand	V8 bi-turbo petrol engine with direct fuel injection, Audi valvelift system and Audi cylinder on demand
Displacement in cc (valves per cylinder)	6,299 (4)	3,993 (4)
Max. output ¹ in kW at rpm	368/6,200	382/5,800
Max. torque in Nm at rpm	625/4,750	650/1,700–5,500
Power transmission/wheels		
Drive type	quattro® permanent all-wheel drive	quattro® permanent all-wheel drive
Transmission type	8-speed tiptronic	8-speed tiptronic
Wheels	Cast aluminium wheels, 9 J x 19	Cast aluminium wheels, 9 J x 20
Tyres	255/45 R 19 ²	265/40 R 20 ²
Weights/capacities		
Unladen weight ³ in kg	2,150	2,065
Gross vehicle weight in kg	2,675	2,590
Roof load/trailer nose weight in kg	100/95	100/95
Trailer load limit ⁴ in kg unbraked	750	750
12 % gradient	2,300	2,300
8 % gradient	2,300	2,300
Fuel tank capacity, approx. in l	82	82
Performance/consumption⁵		
Top speed in km/h	250 ⁶	250 ⁶
Acceleration 0–100 km/h in s	4.6	4.1
Fuel grade	Sulphur-free super RON 95 ⁷	Sulphur-free super plus RON 98 ⁸
Fuel consumption ¹⁰ in l/100 km		
urban	15.7	13.6
extra-urban	8.7	7.3
combined	11.3	9.6
CO ₂ emissions ¹⁰ in g/km		
urban	365	318
extra-urban	204	171
combined	264	225
Emission standard	EU6	EU6

Technical data Dimensions Standard/optional equipment

The Audi A8 L hybrid is the longest Audi sedan ever produced, with a wheelbase of 3,009 mm (118.5 inches)

Model	A8 hybrid/A8 L hybrid (155 kW)
Engine type	4-cylinder inline petrol engine with direct fuel injection, turbocharging and Audi valvelift system
Displacement in cc (valves per cylinder)	1,984 (4)
Max. output ¹ in kW at rpm	155/4,200–6,000
Max. torque in Nm at rpm	350/1,500–4,200
Hybrid drive	
Electrical output in kW	40 ¹²
System output in kW	180 ¹²
Overall torque in Nm	480 ¹²
Battery type	Lithium-ion battery system
Battery energy content in kWh	1.25

Power transmission/wheels		
Drive type	Front-wheel drive	
Transmission type	8-speed tiptronic with integrated electric motor	
Wheels	Cast aluminium wheels, 8 J x 18	
Tyres	235/55 R 18 ²	
Weights/capacities	A8 hybrid	A8 L hybrid
Unladen weight ³ in kg	1,945	1,995
Gross vehicle weight in kg	2,510	2,520
Roof load/trailer nose weight in kg	100/–	100/–
Trailer load limit ⁴ in kg unbraked	–	–
12 % gradient	–	–
8 % gradient	–	–
Fuel tank capacity, approx. in l	78	78

The Audi A8 L hybrid is the longest Audi sedan ever produced, with a wheelbase of 3,009 mm (118.5 inches)

Model	A8 hybrid/A8 L hybrid (155 kW)	
Performance/consumption ⁵	A8 hybrid	A8 L hybrid
Top speed in km/h	235	228
Acceleration 0–100 km/h in s	7.7	7.9
Fuel grade	Sulphur-free super RON 95 ⁷	
Fuel consumption ¹⁰ in l/100 km		
urban	6.1	6.2
extra-urban	6.2	6.3
combined	6.2	6.3
CO ₂ emissions ¹⁰ in g/km		
urban	141	143
extra-urban	146	148
combined	144	146
Emission standard	EU6	EU6

Explanatory notes

¹ The figure given was calculated using the specified measuring procedure (current version of UN-R 85).

² You will find specifications on the technical characteristics of tyres in the adjacent table.

³ Unladen weight includes driver (75 kg) and fuel tank 90% full, calculated in accordance with the current version of Reg. (EU) 1230/2012. Optional equipment may increase the car’s unladen weight and drag coefficient, whereupon the possible payload limit and the top speed will be reduced accordingly.

⁴ The engine’s power output always decreases with increasing altitude. At 1,000 m above sea level, and for every additional 1,000 m, deduct 10 % from the weight of the outfit (trailer load limit + gross weight of the towing vehicle). Figure for trailer load limit applies to factory-fitted trailer towing hitch. If using the vehicle with a trailer towing hitch for commercial purposes, a digital tachograph may be required under certain conditions.

⁵ A vehicle’s fuel consumption and CO₂ emissions as well as deviations from the figures given do not just depend on how efficiently the vehicle uses the fuel, but are also influenced by driving behaviour and other non-technical factors. The figures given for fuel consumption and CO₂ emissions refer to the relevant standard wheel/tyre combination represented and could change if a different wheel or tyre dimenson is chosen. CO₂ is the greenhouse gas primarily responsible for global warming.

⁶ Regulated.

⁷ We recommend using sulphur-free super unleaded RON 95 fuel complying with DIN EN 228. If this is not available, use sulphur-free regular unleaded RON 91 fuel complying with DIN EN 228; power output will be slightly reduced. Unleaded RON 95 fuel with a maximum ethanol content of 10 % (E10) can generally be used. Fuel consumption details refer to operation with RON 95 fuel complying with 692/2008/EC.

⁸ We recommend using sulphur-free super plus unleaded RON 98 fuel complying with DIN EN 228. If this is not available, use sulphur-free super unleaded RON 95 fuel complying with DIN EN 228; power output will be slightly reduced. Unleaded RON 95 fuel with a maximum ethanol content of 10 % (E10) can generally be used. Fuel consumption details refer to operation with RON 95 fuel complying with 692/2008/EC.

⁹ We recommend using sulphur-free diesel complying with DIN EN 590. If this is not available, use diesel complying with DIN EN 590.

¹⁰ The figures given were calculated using the specified measuring procedures. The figures do not refer to one individual vehicle and do not form part of any offer, but rather should be used purely for purposes of comparison between the different vehicle models.

¹¹ Refill the separate AdBlue* tank as indicated by the information in the display of the instrument cluster. We recommend having the AdBlue tank refilled by your Audi partner.

¹² Briefly.















Important note

Special information about the wheels: wheels with gloss turned finish as well as polished or partly polished aluminium wheels may not be used in wintry road conditions. For manufacturing reasons, the wheel rim surface does not have sufficient corrosion protection and it can be permanently damaged by road salt or similar.

Audi A8 L hybrid

Classifications of tyre parameters

The table shows the range of fuel efficiency, wet grip and exterior noise emission classes for the different tyre sizes of the Audi A8, A8 hybrid, A8 L, A8 L hybrid, A8 L W12 and Audi S8.

	Tyre size	Fuel efficiency class	Wet grip class	Exterior noise emission class	
Summer tyres	235/60 R 17	F–E	B	71	
	235/55 R 18	E–C	C–B	72–68	 – 
	255/45 R 19	E	C–B	73–68	 – 
	265/40 R 20	E–C	B	74–71	 – 
Winter tyres	265/35 R 21	E	B	73	
	275/35 R 21	F–E	B	73–71	
	235/60 R 17	F–E	E	73–72	 – 
	235/55 R 18	E–C	C–B	72–70	
	235/50 R 19	E	C	69–68	
	265/40 R 20	E	C	70	

It is not possible to order a specific tyre. Ask your Audi partner about the range of tyres available in your country.

^[*] Registered trademark of the Verband der Automobilindustrie e. V. (VDA).

Audi A8

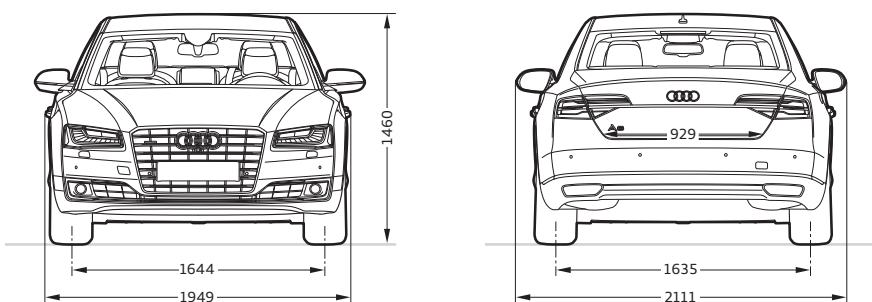
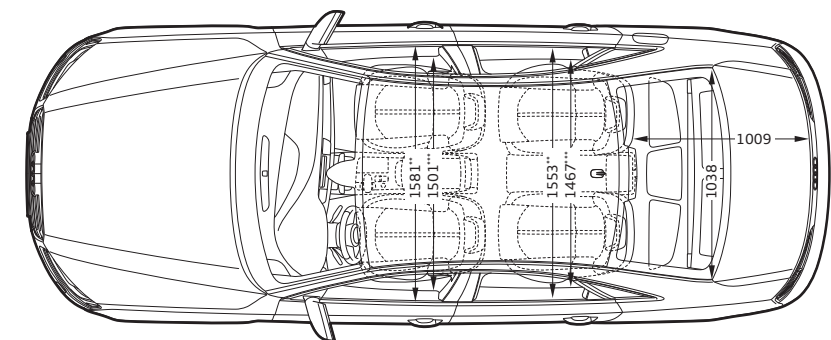
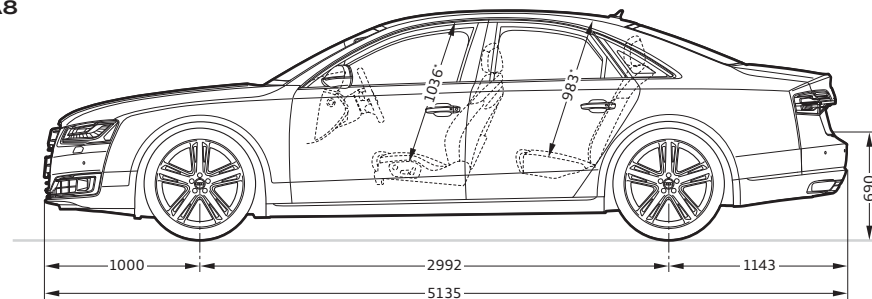
**Dimensions in millimetres.**

Dimensions were measured with vehicle at unladen weight, ground clearance measured with vehicle carrying its maximum load. Luggage compartment volume for the A8 520 l and for the A8 hybrid 335 l.

Usable luggage space may be reduced by optional features.

Diesel models with AdBlue¹ tank have 30 l less luggage space.

Turning circle approx. 12.3 m.

*Maximum headroom, depending on equipment. **Elbow room width. ***Shoulder room width.

Audi A8 L/A8 L W12

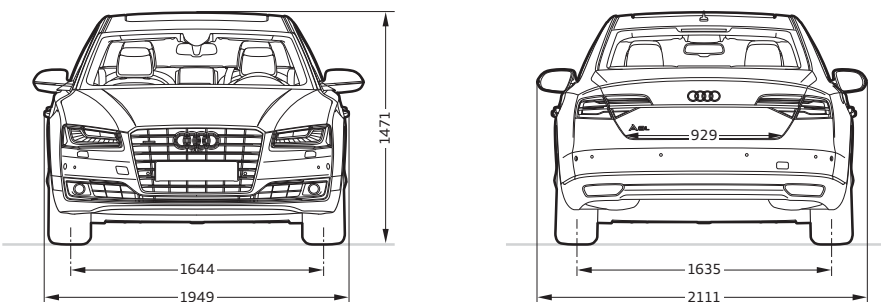
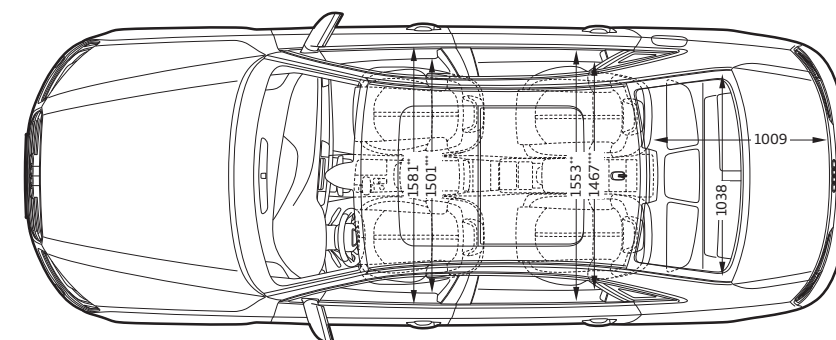
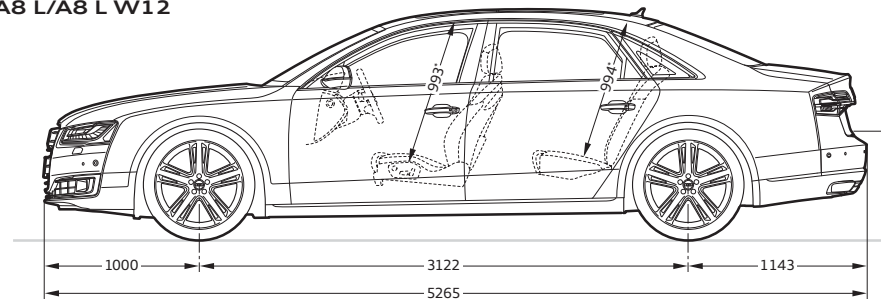
**Dimensions in millimetres.**

Dimensions were measured with vehicle at unladen weight, ground clearance measured with vehicle carrying its maximum load. Luggage compartment volume for the A8 L/A8 L W12 520 l and for the A8 L hybrid 335 l.

Usable luggage space may be reduced by optional features.

Diesel models with AdBlue¹ tank have 30 l less luggage space.

Turning circle approx. 12.7 m.

*Maximum headroom, depending on equipment. **Elbow room width. ***Shoulder room width.

Audi S8

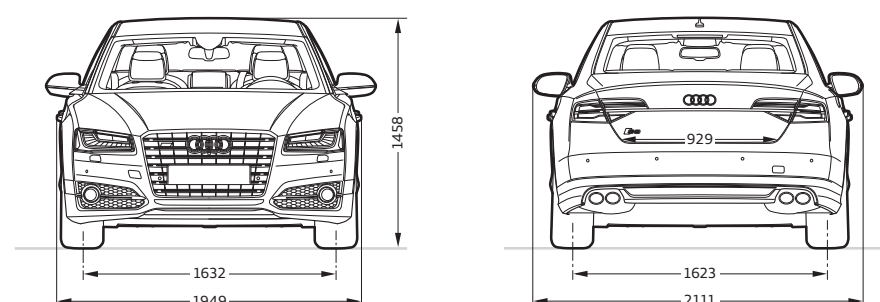
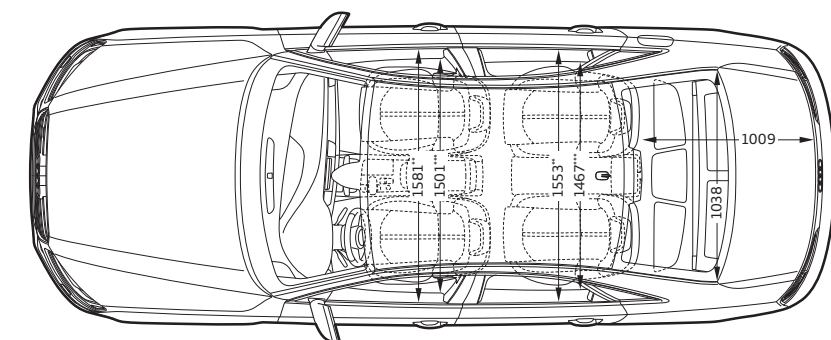
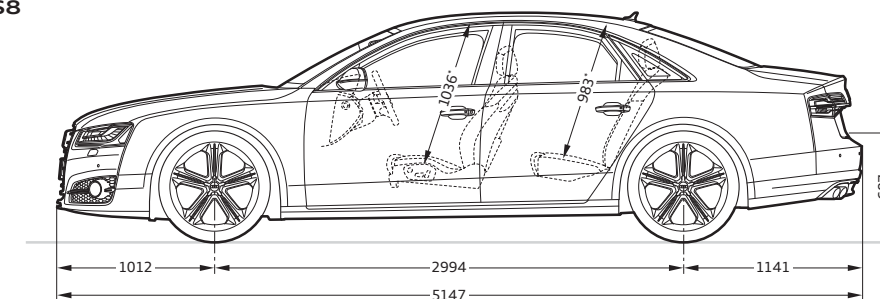











**Dimensions in millimetres.**

Dimensions were measured with vehicle at unladen weight, ground clearance measured with vehicle carrying its maximum load. Luggage compartment volume 520 l. Usable luggage space may be reduced by optional features.

Turning circle approx. 12.7 m.

*Maximum headroom, depending on equipment. **Elbow room width. ***Shoulder room width.

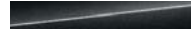
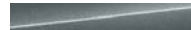







¹Registered trademark of the Verband der Automobilindustrie e. V. (VDA).









	Page	A8	A8 hybrid	S8	A8 L	A8 L hybrid	A8 L W12
Audi design selection	58						
Audi design selection Vermont brown		—	—	■	—	—	—
Audi design selection sycamore grey		■	■	■	■	■	■
Audi design selection Balao brown		■	■	■	■	■	■
Solid paint finishes	68						
 Ibis white		□	□	□	□	□	□
 Brilliant black		□	□	□	□	□	□
Metallic paint finishes	69						
 Havana black, metallic		■	□	■	■	□	□
 Argus brown, metallic		■	□	■	■	□	□
 Moonlight blue, metallic		■	□	■	■	□	□
 Oolong grey, metallic		■	□	■	■	□	□
 Monsoon grey, metallic		■	□	■	■	□	□
 Cuvée silver, metallic		■	□	■	■	□	□
 Floret silver, metallic		■	□	■	■	□	□
 Glacier white, metallic		■	□	■	■	□	□
Pearl effect paint finishes	69						
 Phantom black, pearl effect		■	□	■	■	□	□
 Daytona grey, pearl effect		—	—	■	—	—	—
Customised paint finishes	64/69						
 Audi exclusive customised paint finishes		■	■	■	■	■	■
Wheels/tyres	70						
 17" forged aluminium wheels in 6-arm design		□ ¹	—	—	□ ¹	—	—









□ Standard equipment ■ Optional equipment — Not available

Country-specific variations possible. Please find out from your local Audi partner which equipment is standard and what optional equipment is available in your country.







More detailed descriptions of a selection of items from the equipment range can be found from page 52 onwards.

	A8	A8 hybrid	S8	A8 L	A8 L hybrid	A8 L W12
 18" cast aluminium wheels in 10-spoke V design	□ ²	—	—	□ ²	—	—
 18" cast aluminium wheels in 10-arm turbine design (hybrid design)	—	□	—	—	□	—
 19" cast aluminium wheels in 5-arm design	■	■	—	■	■	□
 19" cast aluminium wheels in 10-spoke Y design, partly polished ³	■	—	—	■	—	■
 19" cast aluminium wheels in 10-arm turbine design (hybrid design), contrasting grey, partly polished ³	—	■	—	—	■	—
 19" cast aluminium wheels in 15-spoke design, partly polished ³	■	—	—	■	—	■
 19" Audi Sport cast aluminium wheels in 5-V-spoke design in matt titanium look, gloss turned finish ³	■	—	—	■	—	■
 19" Audi Sport cast aluminium wheels in 7-twin-spoke design	■	—	—	■	—	■

	A8	A8 hybrid	S8	A8 L	A8 L hybrid	A8 L W12
 20" cast aluminium wheels in 10-spoke star design	■	—	—	■	—	■
 20" forged aluminium wheels in 10-parallel-spoke design, partly polished ³	■	■	—	■	■	■
 20" cast aluminium wheels in 5-parallel-spoke design (S design)	—	—	□	—	—	—
 20" forged aluminium wheels in 15-spoke structured design, partly polished ³	■	■	—	■	■	■
 20" forged aluminium wheels in 15-spoke structured design, high-gloss polished finish ³	—	—	—	—	—	■
 20" Audi Sport cast aluminium wheels in 5-twin-spoke design	■	—	■	■	—	■
 20" Audi Sport cast aluminium wheels in 5-twin-spoke design in matt titanium look, gloss turned finish ³	■	—	■	■	—	■
 20" Audi Sport cast aluminium wheels in 5-spoke blade design	■	—	■	■	—	■
 20" Audi Sport cast aluminium wheels in 10-Y-spoke design	■	—	■	■	—	■

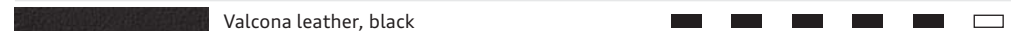
	A8	A8 hybrid	S8	A8 L	A8 L hybrid	A8 L W12
 21" cast aluminium wheels in 5-triple-spoke design (S design)	—	—	■	—	—	—
 21" Audi Sport cast aluminium wheels in 5-arm structured design	■	—	■	■	—	■
 21" Audi Sport cast aluminium wheels in 5-arm rotor design	■	—	■	■	—	■
 21" Audi Sport cast aluminium wheels in 5-arm rotor design, matt titanium look, gloss turned finish ³	■	—	■	■	—	■
 17" cast aluminium winter wheels in 6-arm design	■	—	—	■	—	—
 18" cast aluminium winter wheels in 7-arm design	■	■	—	■	■	—
 19" cast aluminium winter wheels in 5-arm design	■	—	■	■	—	■
 20" cast aluminium winter wheels in 5-parallel-spoke design (S design)	—	—	■	—	—	—
 20" forged aluminium winter wheels in 10-parallel-spoke design	■	—	—	■	—	■

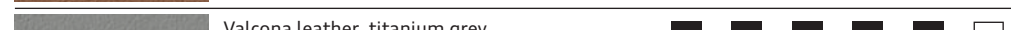
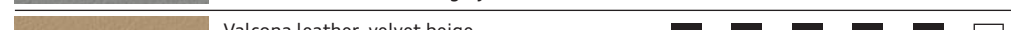













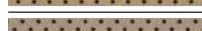

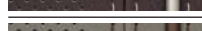
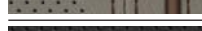
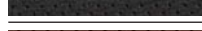
¹Standard for 6-cylinder models. ²Standard for 8-cylinder models. ³Please note the special information relating to wheels on page 99.

	Page	A8	A8 hybrid	S8	A8 L	A8 L hybrid	A8 L W12
Wheels/tyres (continued)							
Run-flat tyres		■	–	–	■	–	■
Tyre repair kit		□	□	□	□	□	□
Spare wheel, space-saving		■	–	■	■	–	■
Tyre pressure loss indicator		□	□	□	□	□	□
Anti-theft wheel bolts		□	□	□	□	□	□
Vehicle tool kit		□	□	□	□	□	□
Vehicle jack		■	–	■	■	–	■
Seats for driver and front passenger 72							
Standard seats, front		□	□	–	□	□	–
Comfort seats, front		■	■	■	■	■	□
Comfort seats, front with seat ventilation		■	■	■	■	■	■
Comfort sport seats, front		■	■	□	■	■	■
Comfort sport seats, front with seat ventilation		■	■	■	■	■	■
Seat upholstery for standard seats, front 74							
 Verdi cloth		□	□	–	□	□	–
 Valcona leather, black		■	■	–	■	■	–
 Valcona leather, velvet beige		■	■	–	■	■	–
Seat upholstery for comfort seats, front 74							
 Valcona leather, black		■	■	■	■	■	□
 Valcona leather, nougat brown		■	■	■	■	■	□
 Valcona leather, nutmeg		■	■	■	■	■	□
 Valcona leather, titanium grey		■	■	■	■	■	□
 Valcona leather, velvet beige		■	■	■	■	■	□
 Valcona leather, Atlas beige		■	■	■	■	■	□
 Audi exclusive leather upholstery and trim		■	■	■	■	■	■

□ Standard equipment ■ Optional equipment – Not available

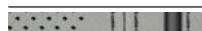

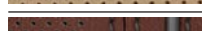

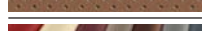





Country-specific variations possible. Please find out from your local Audi partner which equipment is standard and what optional equipment is available in your country.





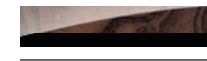
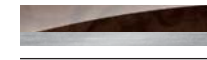

More detailed descriptions of a selection of items from the equipment range can be found from page 52 onwards.

	Page	A8	A8 hybrid	S8	A8 L	A8 L hybrid	A8 L W12
Seat upholstery for comfort seats, front with seat ventilation 74							
 Valcona leather, black		■	■	■	■	■	■
 Valcona leather, nougat brown		■	■	■	■	■	■
 Valcona leather, nutmeg		■	■	■	■	■	■
 Valcona leather, titanium grey		■	■	■	■	■	■
 Valcona leather, velvet beige		■	■	■	■	■	■
 Valcona leather, Atlas beige		■	■	■	■	■	■
 Valcona leather, Balao brown/snow white ¹		■ ¹	■ ¹	■ ¹	■ ¹	■ ¹	■ ¹
 Valcona leather, sycamore grey/brass gold ¹		■ ¹	■ ¹	■ ¹	■ ¹	■ ¹	■ ¹
 Natural leather, black		■	■	■	■	■	■
 Natural leather, nougat brown		■	■	■	■	■	■
 Natural leather, velvet beige		■	■	■	■	■	■
 Audi exclusive leather upholstery and trim		■	■	■	■	■	■
Seat upholstery for comfort sport seats, front with and without seat ventilation 74							
 Valcona leather, black		■	■	□	■	■	■
 Valcona leather, nougat brown		■	■	□	■	■	■
 Valcona leather, titanium grey		■	■	□	■	■	■
 Valcona leather, lunar silver/steel grey		–	–	□	–	–	–
 Valcona leather, velvet beige		■	■	□	■	■	■
 Valcona leather, Vermont brown/granite grey		–	–	■ ¹	–	–	–
 Unicum leather, nutmeg		■	■	■	■	■	■
 Audi exclusive leather upholstery and trim		■	■	■	■	■	■
Leather packages 74							
Leather package		■	■	□	■	■	–
Extended leather package		■	■	■	■	■	□

	Page	A8	A8 hybrid	S8	A8 L	A8 L hybrid	A8 L W12
Full-leather package		■	■	■	■	■	■
Audi exclusive leather upholstery and trim (package 1)		■	■	■	■	■	■
Audi exclusive leather upholstery and trim (package 2)		■	■	■	■	■	■
Audi exclusive leather upholstery and trim (package 3)		■	■	■	■	■	■
Audi exclusive leather upholstery and trim (package 4)		■	■	■	■	■	■
Headlinings 76							
Headlining in cloth		□	□	□	□	□	–
Headlining in cloth, black		■	■	■	■	■	–
Headlining and rear parcel shelf in Alcantara		■	■	■	■	■	□
Headlining and rear parcel shelf in Alcantara, black		■	■	■	■	■	■
Audi exclusive headlining in Alcantara		■	■	■	■	■	■
Audi exclusive rear shelf in Alcantara		■	■	■	■	■	■
Seating comfort 76							
Seat heating, front		■	■	□	■	■	–
Seat heating, front and rear		■	■	■	■	■	□
Seat ventilation, front		■	■	■	■	■	■
Seat ventilation, front and rear		■	–	■	■	■	■
Massage function, front		■	■	■	■	■	■
Massage function, front and rear		■	–	■	■	■	■
Centre armrest, front		□	□	–	□	□	–
Comfort centre armrest, front		■	■	□	■	■	□
Memory function for standard seats, front		■	■	–	■	■	–
Rear seats 76							
Centre armrest, rear		□	□	□	□	□	□
Comfort head restraints, rear		■	■	■	■	■	□
Footrests, rear		–	–	–	■	■	■
Audi exclusive rear footrests		–	–	–	■	■	■

¹ Can only be ordered in conjunction with an Audi design selection. ² Only available in conjunction with comfort sport seats, front. ³ From quattro GmbH.

	Page	A8	A8 hybrid	S8	A8 L	A8 L hybrid	A8 L W12
Rear seat package in sport seat look		■ ²	■ ²	■	■ ²	■ ²	■ ²
Rear seat system		□	□	□	□	□	■
Individual seat package, rear		■	■	■	■	■	□
Individual seat package, rear with full-length leather-covered centre console		–	–	–	■	■	■
Relaxation seat package, rear with full-length leather-covered centre console		–	–	–	■	■	■
Upper/lower inlays 78							
 Walnut, dark brown/high-gloss black		□	□	■	□	□	■
 Vavona, Assam grey/high-gloss black		■	■	■	■	■	■
 Poplar, brown silver/high-gloss black		■	■	■	■	■	■
 Fine grain ash, natural gold brown/high-gloss black		■	■	■	■	■	■
 Piano finish, black/high-gloss black		■	■	■	■	■	■
 Carbon Atlas/high-gloss black		–	–	■	–	–	–
 Fine grain birch, pearl beige/high-gloss black ³		■	■	■	■	■	■
 Fine grain ash, velvet brown/high-gloss black ³		■	■	■	■	■	■
 Walnut, dark brown/brushed aluminium, silver		■	■	■	■	■	■
 Vavona, Assam grey/brushed aluminium, silver		■	■	■	■	■	■
 Poplar, brown silver/brushed aluminium, silver		■	■	■	■	■	■
 Fine grain ash, natural gold brown/brushed aluminium, silver		■	■	■	■	■	■

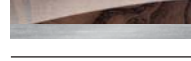
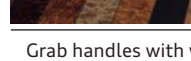
	Page	A8	A8 hybrid	S8	A8 L	A8 L hybrid	A8 L W12
Upper/lower inlays (continued)	78						
 Piano finish, black/brushed aluminium, silver		■	■	■	■	■	□
 Carbon Atlas/brushed aluminium, silver		-	-	□	-	-	-
 Carbon red/brushed aluminium, silver		-	-	■ ¹	-	-	-
 Fine grain ash, natural balsamic brown/brushed aluminium, silver ¹		■	■	■	■	■	■
 Fine grain ash, natural pearl grey/brushed aluminium, silver		■	■	■	■	■	■
 Fine grain birch, pearl beige/brushed aluminium, silver ²		■	■	■	■	■	■
 Fine grain ash, velvet brown/brushed aluminium, silver ²		■	■	■	■	■	■
 Audi exclusive inlays		■	■	■	■	■	■
Grab handles with wooden segments		■	■	■	■	■	□
Audi exclusive grab handles with wooden segments		■	■	■	■	■	■
Aluminium-look interior		□	□	-	□	□	-
Extended aluminium-look interior		■	■	□	■	■	□
Headlights	80						
Xenon plus		□	-	-	□	-	-
LED headlights		■	□	□	■	□	-
Audi Matrix LED headlights		■	■	■	■	■	□
Light/rain sensor		□	□	□	□	□	□
LED rear lights		□	-	-	□	-	-
LED rear lights with dynamic indicators ³		■	□	□	■	□	□
Adaptive brake light		□	□	□	□	□	□

□ Standard equipment ■ Optional equipment □ Standard/optional equipment varies by model - Not available

Country-specific variations possible. Please find out from your local Audi partner which equipment is standard and what optional equipment is available in your country.

More detailed descriptions of a selection of items from the equipment range can be found from page 52 onwards.

	Page	A8	A8 hybrid	S8	A8 L	A8 L hybrid	A8 L W12
Interior lighting	80						
Interior and exterior lighting package		□	□	□	□	□	□
Ambient lighting		■	□	□	■	□	□
Additional reading lights in the rear		■	■	■	■	■	□
Vanity mirrors and additional reading lights in the rear		-	-	-	■	■	□
Audi exclusive cardan reading lights in the rear		■	■	■	■	■	■
Exterior design	55						
Model name/logo		□	□	□	□	□	□
Audi Singleframe		□	□	□	□	□	-
Audi Singleframe, W12-specific with close-mesh honeycomb structure in chrome		-	-	-	-	-	□
Diffuser insert at rear		-	-	□	-	-	-
Exhaust tailpipes, dual-branch design with trapezoidal chrome surrounds integrated into the bumper		□	□	-	□	□	□
Exhaust tailpipes, dual-branch design, 2 oval chrome surrounds on both left and right		-	-	□	-	-	-
Interior design	81						
Analogue clock		□	□	□	□	□	□
Floor mats, front and rear		□	□	□	□	□	□
Audi exclusive floor mats		■	■	■	■	■	■
Audi exclusive carpet and floor mats		■	■	■	■	■	■
Pedals and footrest in stainless steel		-	-	□	-	-	-
Door sill trims with aluminium inlays		□	-	-	□	-	-
Door sill trims with aluminium inlays with model-specific illuminated logo		-	□	□	-	□	□
Audi exclusive personalised door sill trims, front		■	■	■	■	■	■
Audi exclusive personalised door sill trims, front and rear		■	■	■	■	■	■

	Page	A8	A8 hybrid	S8	A8 L	A8 L hybrid	A8 L W12
Steering wheels/controls	82						
Multifunction leather steering wheel in 4-spoke design with shift paddles		□ ⁴	□	■	□ ⁴	□	□
Multifunction leather steering wheel in 4-spoke design with shift paddles, heated		■	■	■	■	■	■
Multifunction sport leather steering wheel in 3-spoke design with shift paddles		□ ⁵	■	□	□ ⁵	■	■
Multifunction sport leather steering wheel in 3-spoke design with shift paddles, heated		■	■	■	■	■	■
Electric steering wheel adjustment		□	□	□	□	□	□
Selector lever in leather		□	□	■	□	□	□
Selector lever in wood ⁶		■	■	■	■	■	■
Audi exclusive selector lever in wood		■	■	■	■	■	■
Selector lever in carbon Atlas		-	-	□	-	-	-
Selector lever in piano finish, black		-	-	■ ⁷	-	-	□
Steering wheel rim with wooden segments		■	■	■	■	■	■
Audi exclusive steering wheel rim with wooden segments		■	■	■	■	■	■
Audi exclusive leather steering wheel		■	■	■	■	■	■
Audi exclusive leather controls		■	■	■	■	■	■
Mirrors							
Exterior mirrors with integrated LED indicator, electrically adjustable, heated and folding, including automatic kerb-side function for the exterior mirror on the passenger side		□	□	□	□	□	□
Exterior mirrors additionally automatically dimming on both sides		■	■	-	■	■	-
Exterior mirrors additionally automatically dimming on both sides with memory function		■	■	□	■	■	□

	Page	A8	A8 hybrid	S8	A8 L	A8 L hybrid	A8 L W12
Exterior mirror housings in aluminium look		-	-	□	-	-	-
Exterior mirror housings in body colour with integrated chrome strip		-	-	-	-	-	□
Interior mirror, automatically dimming		□	□	□	□	□	□
Roof systems	83						
Slide-and-tilt glass sunroof		■	■	■	□	□	□
Solar slide-and-tilt sunroof		■	■	■	■	■	■
Panoramic glass sunroof		-	-	-	■	■	■
Glazing	84						
Heat-insulating glass		□	□	-	□	□	-
Dark-tinted windows (privacy glazing)		■	■	■	■	■	■
Double/acoustic glazing		■	■	□	■	■	■
Insulating/acoustic glass		■	■	■	■	■	□
Windscreen heater		■	-	■	■	-	■
Sunblind, electric for the rear window		■	■	■	-	-	-
Sunblinds, electric, for the rear window and rear door windows		■	■	■	□	□	□
Climate control	84						
Deluxe automatic air conditioning		□	-	□	□	-	-
3-zone deluxe automatic air conditioning		-	□	-	-	□	-
4-zone deluxe automatic air conditioning		■	-	■	■	-	□
Auxiliary heating/ventilation		■	-	■	■	-	■
Ioniser		■	■	■	■	■	■

¹ Can only be ordered in conjunction with an Audi design selection. ² From quattro GmbH. ³ Only available in conjunction with LED headlights or Audi Matrix LED headlights. ⁴ Standard for 6-cylinder models and 4.0 TFSI.

⁵ Standard for 4.2 TDI clean diesel quattro. ⁶ Cannot be ordered in conjunction with inlays specified as natural. ⁷ Only available in conjunction with the Audi design selection Vermont brown.

	Page	A8	A8 hybrid	S8	A8 L	A8 L hybrid	A8 L W12
Closing systems	85						
Remote control key		<input type="checkbox"/>	<input type="checkbox"/>	—	<input type="checkbox"/>	<input type="checkbox"/>	—
Engine start-stop button		<input type="checkbox"/>	<input type="checkbox"/>	<input type="checkbox"/>	<input type="checkbox"/>	<input type="checkbox"/>	<input type="checkbox"/>
Luggage compartment lid, automatically opening		<input type="checkbox"/>	<input type="checkbox"/>	<input type="checkbox"/>	<input type="checkbox"/>	<input type="checkbox"/>	<input type="checkbox"/>
Luggage compartment lid, electric opening and closing		<input checked="" type="checkbox"/>	<input checked="" type="checkbox"/>	<input checked="" type="checkbox"/>	<input checked="" type="checkbox"/>	<input checked="" type="checkbox"/>	<input type="checkbox"/>
Convenience key including sensor-controlled release of the luggage compartment lid		<input checked="" type="checkbox"/>	<input checked="" type="checkbox"/>	<input type="checkbox"/>	<input checked="" type="checkbox"/>	<input checked="" type="checkbox"/>	<input type="checkbox"/>
Power-assisted closing for the doors		<input checked="" type="checkbox"/>	<input checked="" type="checkbox"/>	<input checked="" type="checkbox"/>	<input checked="" type="checkbox"/>	<input checked="" type="checkbox"/>	<input type="checkbox"/>
Power-assisted closing for the luggage compartment lid		<input type="checkbox"/>	<input type="checkbox"/>	<input type="checkbox"/>	<input type="checkbox"/>	<input type="checkbox"/>	<input type="checkbox"/>
Garage door opener (HomeLink)		<input checked="" type="checkbox"/>	<input checked="" type="checkbox"/>	<input checked="" type="checkbox"/>	<input checked="" type="checkbox"/>	<input checked="" type="checkbox"/>	<input checked="" type="checkbox"/>
Anti-theft alarm		<input type="checkbox"/>	<input type="checkbox"/>	<input type="checkbox"/>	<input type="checkbox"/>	<input type="checkbox"/>	<input type="checkbox"/>
Preparation for tracking system		<input checked="" type="checkbox"/>	<input checked="" type="checkbox"/>	<input checked="" type="checkbox"/>	<input checked="" type="checkbox"/>	<input checked="" type="checkbox"/>	<input checked="" type="checkbox"/>
Storage/transport	85						
Storage compartments		<input type="checkbox"/>	<input type="checkbox"/>	<input type="checkbox"/>	<input type="checkbox"/>	<input type="checkbox"/>	<input type="checkbox"/>
Cup holder		<input type="checkbox"/>	<input type="checkbox"/>	<input type="checkbox"/>	<input type="checkbox"/>	<input type="checkbox"/>	<input type="checkbox"/>
Luggage compartment package		<input checked="" type="checkbox"/>	<input checked="" type="checkbox"/> ¹	<input checked="" type="checkbox"/>	<input checked="" type="checkbox"/>	<input checked="" type="checkbox"/> ¹	<input checked="" type="checkbox"/>
Through-loading facility		<input checked="" type="checkbox"/>	—	<input checked="" type="checkbox"/>	<input checked="" type="checkbox"/>	—	<input checked="" type="checkbox"/>
Through-loading facility with removable ski/snowboard bag		<input checked="" type="checkbox"/>	—	<input checked="" type="checkbox"/>	<input checked="" type="checkbox"/>	—	<input checked="" type="checkbox"/>
Audi exclusive coolbox		<input checked="" type="checkbox"/>	—	<input checked="" type="checkbox"/>	<input checked="" type="checkbox"/>	—	<input checked="" type="checkbox"/>
Non-smoker package		<input checked="" type="checkbox"/>	<input checked="" type="checkbox"/>	<input checked="" type="checkbox"/>	<input checked="" type="checkbox"/>	<input checked="" type="checkbox"/>	<input checked="" type="checkbox"/>
Cigarette lighter and ashtray		<input type="checkbox"/>	<input type="checkbox"/>	<input type="checkbox"/>	<input type="checkbox"/>	<input type="checkbox"/>	<input type="checkbox"/>
230V/115V/100V socket		<input checked="" type="checkbox"/>	<input checked="" type="checkbox"/>	<input checked="" type="checkbox"/>	<input checked="" type="checkbox"/>	<input checked="" type="checkbox"/>	<input checked="" type="checkbox"/>
Audi exclusive bar compartment		—	—	—	<input checked="" type="checkbox"/>	—	<input checked="" type="checkbox"/>
Audi exclusive storage compartment		—	—	—	<input checked="" type="checkbox"/>	—	<input checked="" type="checkbox"/>
Audi exclusive folding table		<input checked="" type="checkbox"/>	<input checked="" type="checkbox"/>	<input checked="" type="checkbox"/>	<input checked="" type="checkbox"/>	<input checked="" type="checkbox"/>	<input checked="" type="checkbox"/>
Audi exclusive personalisation of the folding table		<input checked="" type="checkbox"/>	<input checked="" type="checkbox"/>	<input checked="" type="checkbox"/>	<input checked="" type="checkbox"/>	<input checked="" type="checkbox"/>	<input checked="" type="checkbox"/>

Standard equipment Optional equipment Standard/optional equipment varies by model — Not available

Country-specific variations possible. Please find out from your local Audi partner which equipment is standard and what optional equipment is available in your country.

More detailed descriptions of a selection of items from the equipment range can be found from page 52 onwards.

	Page	A8	A8 hybrid	S8	A8 L	A8 L hybrid	A8 L W12
A8 hybrid luggage set		—	<input type="checkbox"/>	—	—	<input type="checkbox"/>	—
Provision for trailer towing hitch ²		<input checked="" type="checkbox"/>	—	<input checked="" type="checkbox"/>	<input checked="" type="checkbox"/>	—	<input checked="" type="checkbox"/>
Trailer towing hitch, electrically swivelling		<input checked="" type="checkbox"/>	—	<input checked="" type="checkbox"/>	<input checked="" type="checkbox"/>	—	<input checked="" type="checkbox"/>
MMI®/navigation	87						
Instrument cluster		<input type="checkbox"/>	<input type="checkbox"/>	<input type="checkbox"/>	<input type="checkbox"/>	<input type="checkbox"/>	<input type="checkbox"/>
Powermeter in the instrument cluster		—	<input type="checkbox"/>	—	—	<input type="checkbox"/>	—
Driver information system with colour display		<input type="checkbox"/>	<input type="checkbox"/>	<input type="checkbox"/>	<input type="checkbox"/>	<input type="checkbox"/>	<input type="checkbox"/>
Attention assist		<input type="checkbox"/>	<input type="checkbox"/>	<input type="checkbox"/>	<input type="checkbox"/>	<input type="checkbox"/>	<input type="checkbox"/>
MMI®		<input type="checkbox"/>	<input type="checkbox"/>	<input type="checkbox"/>	<input type="checkbox"/>	<input type="checkbox"/>	—
MMI® touch		<input checked="" type="checkbox"/>	<input checked="" type="checkbox"/>	<input checked="" type="checkbox"/>	<input checked="" type="checkbox"/>	<input checked="" type="checkbox"/>	—
MMI® navigation plus with MMI touch		<input checked="" type="checkbox"/>	<input checked="" type="checkbox"/>	<input checked="" type="checkbox"/>	<input checked="" type="checkbox"/>	<input checked="" type="checkbox"/>	<input type="checkbox"/>
Navigation data (hard drive)		<input checked="" type="checkbox"/>	<input checked="" type="checkbox"/>	<input checked="" type="checkbox"/>	<input checked="" type="checkbox"/>	<input checked="" type="checkbox"/>	<input type="checkbox"/>
Entertainment	88						
MMI® radio plus		<input type="checkbox"/>	<input type="checkbox"/>	<input type="checkbox"/>	<input type="checkbox"/>	<input type="checkbox"/>	<input type="checkbox"/>
Digital Audio Broadcasting		<input checked="" type="checkbox"/>	<input checked="" type="checkbox"/>	<input checked="" type="checkbox"/>	<input checked="" type="checkbox"/>	<input checked="" type="checkbox"/>	<input checked="" type="checkbox"/>
Digital TV reception		<input checked="" type="checkbox"/>	<input checked="" type="checkbox"/>	<input checked="" type="checkbox"/>	<input checked="" type="checkbox"/>	<input checked="" type="checkbox"/>	<input checked="" type="checkbox"/>
Audi music interface		<input checked="" type="checkbox"/>	<input checked="" type="checkbox"/>	<input checked="" type="checkbox"/>	<input checked="" type="checkbox"/>	<input checked="" type="checkbox"/>	<input type="checkbox"/>
DVD/CD changer		<input checked="" type="checkbox"/>	<input checked="" type="checkbox"/>	<input type="checkbox"/>	<input checked="" type="checkbox"/>	<input checked="" type="checkbox"/>	<input type="checkbox"/>
Audi sound system		<input type="checkbox"/>	—	<input type="checkbox"/>	<input type="checkbox"/>	—	—
Bose Surround Sound		<input checked="" type="checkbox"/>	<input type="checkbox"/>	<input checked="" type="checkbox"/>	<input checked="" type="checkbox"/>	<input type="checkbox"/>	<input type="checkbox"/>
Bang & Olufsen Advanced Sound System		<input checked="" type="checkbox"/>	<input checked="" type="checkbox"/>	<input checked="" type="checkbox"/>	<input checked="" type="checkbox"/>	<input checked="" type="checkbox"/>	<input checked="" type="checkbox"/>
Rear Seat Entertainment		<input checked="" type="checkbox"/>	—	<input checked="" type="checkbox"/>	<input checked="" type="checkbox"/>	<input checked="" type="checkbox"/>	<input checked="" type="checkbox"/>
Communication	89						
Audi connect including car phone		<input checked="" type="checkbox"/>	<input checked="" type="checkbox"/>	<input checked="" type="checkbox"/>	<input checked="" type="checkbox"/>	<input checked="" type="checkbox"/>	<input type="checkbox"/>
Audi phone box		<input checked="" type="checkbox"/>	<input checked="" type="checkbox"/>	<input checked="" type="checkbox"/>	<input checked="" type="checkbox"/>	<input checked="" type="checkbox"/>	<input checked="" type="checkbox"/>
Bluetooth interface		<input checked="" type="checkbox"/>	<input checked="" type="checkbox"/>	<input checked="" type="checkbox"/>	<input checked="" type="checkbox"/>	<input checked="" type="checkbox"/>	<input type="checkbox"/>

	Page	A8	A8 hybrid	S8	A8 L	A8 L hybrid	A8 L W12
Mobile phone holder in the rear		—	—	—	—	—	<input type="checkbox"/>
Handset in the front for car phone		<input checked="" type="checkbox"/>	<input checked="" type="checkbox"/>	<input checked="" type="checkbox"/>	<input checked="" type="checkbox"/>	<input checked="" type="checkbox"/>	<input type="checkbox"/>
Handsets in the front and rear for car phone		<input checked="" type="checkbox"/>	<input checked="" type="checkbox"/>	<input checked="" type="checkbox"/>	<input checked="" type="checkbox"/>	<input checked="" type="checkbox"/>	<input checked="" type="checkbox"/>
Assistance systems	90						
Hold assist		<input type="checkbox"/>	<input type="checkbox"/>	<input type="checkbox"/>	<input type="checkbox"/>	<input type="checkbox"/>	<input type="checkbox"/>
Parking system plus		<input checked="" type="checkbox"/>	<input checked="" type="checkbox"/>	<input type="checkbox"/>	<input checked="" type="checkbox"/>	<input checked="" type="checkbox"/>	<input type="checkbox"/>
Park assist with display of surroundings		<input checked="" type="checkbox"/>	<input checked="" type="checkbox"/>	<input checked="" type="checkbox"/>	<input checked="" type="checkbox"/>	<input checked="" type="checkbox"/>	<input checked="" type="checkbox"/>
Reversing camera		<input checked="" type="checkbox"/>	<input checked="" type="checkbox"/>	<input checked="" type="checkbox"/>	<input checked="" type="checkbox"/>	<input checked="" type="checkbox"/>	<input type="checkbox"/>
360 degree cameras		<input checked="" type="checkbox"/>	<input checked="" type="checkbox"/>	<input checked="" type="checkbox"/>	<input checked="" type="checkbox"/>	<input checked="" type="checkbox"/>	<input checked="" type="checkbox"/>
Cruise control		<input type="checkbox"/>	<input type="checkbox"/>	<input type="checkbox"/>	<input type="checkbox"/>	<input type="checkbox"/>	<input type="checkbox"/>
Audi pre sense basic		<input type="checkbox"/>	<input type="checkbox"/>	<input type="checkbox"/>	<input type="checkbox"/>	<input type="checkbox"/>	<input type="checkbox"/>
adaptive cruise control with Stop&Go function including Audi pre sense front		<input checked="" type="checkbox"/>	<input checked="" type="checkbox"/>	<input checked="" type="checkbox"/>	<input checked="" type="checkbox"/>	<input checked="" type="checkbox"/>	<input checked="" type="checkbox"/>
Audi side assist including Audi pre sense rear		<input checked="" type="checkbox"/>	<input checked="" type="checkbox"/>	<input checked="" type="checkbox"/>	<input checked="" type="checkbox"/>	<input checked="" type="checkbox"/>	<input checked="" type="checkbox"/>
Audi active lane assist		<input checked="" type="checkbox"/>	<input checked="" type="checkbox"/>	<input checked="" type="checkbox"/>	<input checked="" type="checkbox"/>	<input checked="" type="checkbox"/>	<input checked="" type="checkbox"/>
Assistance package including Audi pre sense plus		<input checked="" type="checkbox"/>	<input checked="" type="checkbox"/>	<input checked="" type="checkbox"/>	<input checked="" type="checkbox"/>	<input checked="" type="checkbox"/>	<input checked="" type="checkbox"/>
Head-up display		<input checked="" type="checkbox"/>	<input checked="" type="checkbox"/>	<input checked="" type="checkbox"/>	<input checked="" type="checkbox"/>	<input checked="" type="checkbox"/>	<input checked="" type="checkbox"/>
Night vision assistant		<input checked="" type="checkbox"/>	<input checked="" type="checkbox"/>	<input checked="" type="checkbox"/>	<input checked="" type="checkbox"/>	<input checked="" type="checkbox"/>	<input checked="" type="checkbox"/>
Camera-based speed limit display		<input checked="" type="checkbox"/>	<input checked="" type="checkbox"/>	<input checked="" type="checkbox"/>	<input checked="" type="checkbox"/>	<input checked="" type="checkbox"/>	<input checked="" type="checkbox"/>
Driving dynamics/brakes	92						
Audi drive select		<input type="checkbox"/>	<input type="checkbox"/>	<input type="checkbox"/>	<input type="checkbox"/>	<input type="checkbox"/>	<input type="checkbox"/>
adaptive air suspension		<input type="checkbox"/>	<input type="checkbox"/>	—	<input type="checkbox"/>	<input type="checkbox"/>	<input type="checkbox"/>
adaptive air suspension – sport		<input checked="" type="checkbox"/>	<input checked="" type="checkbox"/>	<input type="checkbox"/>	—	—	—
Front-wheel drive		—	<input type="checkbox"/>	—	—	<input type="checkbox"/>	—
quattro®		<input type="checkbox"/>	—	—	<input type="checkbox"/>	—	<input type="checkbox"/>
quattro® with sport differential		<input type="checkbox"/> ³	—	<input type="checkbox"/>	<input type="checkbox"/> ³	—	<input checked="" type="checkbox"/>

	Page	A8	A8 hybrid	S8	A8 L	A8 L hybrid	A8 L W12
tiptronic		<input type="checkbox"/>	<input type="checkbox"/>	<input type="checkbox"/>	<input type="checkbox"/>	<input type="checkbox"/>	<input type="checkbox"/>
Electromechanical power steering		<input type="checkbox"/>	<input type="checkbox"/>	—	<input type="checkbox"/>	<input type="checkbox"/>	<input type="checkbox"/>
Dynamic steering		<input checked="" type="checkbox"/>	—	<input type="checkbox"/>	<input checked="" type="checkbox"/>	—	<input checked="" type="checkbox"/>
Secondary collision brake assist		<input type="checkbox"/>	<input type="checkbox"/>	<input type="checkbox"/>	<input type="checkbox"/>	<input type="checkbox"/>	<input type="checkbox"/>
Brake system		<input type="checkbox"/>	<input type="checkbox"/>	<input type="checkbox"/>	<input type="checkbox"/>	<input type="checkbox"/>	<input type="checkbox"/>
Black painted brake callipers		—	—	<input type="checkbox"/>	—	—	<input type="checkbox"/>
Ceramic brake		<input checked="" type="checkbox"/> ⁴	—	<input checked="" type="checkbox"/>	<input checked="" type="checkbox"/> ⁴	—	<input checked="" type="checkbox"/>
Electromechanical parking brake		<input type="checkbox"/>	<input type="checkbox"/>	<input type="checkbox"/>	<input type="checkbox"/>	<input type="checkbox"/>	<input type="checkbox"/>
Technology/safety	93						
Active Noise Cancellation		<input type="checkbox"/> ⁵	<input type="checkbox"/>	<input type="checkbox"/>	<input type="checkbox"/> ⁵	<input type="checkbox"/>	<input type="checkbox"/>
Audi Space Frame (ASF®) body		<input type="checkbox"/>	<input type="checkbox"/>	<input type="checkbox"/>	<input type="checkbox"/>	<input type="checkbox"/>	<input type="checkbox"/>
Antilock Brake System (ABS) with Electronic Brake Force Distribution (EBD)		<input type="checkbox"/>	<input type="checkbox"/>	<input type="checkbox"/>	<input type="checkbox"/>	<input type="checkbox"/>	<input type="checkbox"/>
Anti-Slip Regulation (ASR)		<input type="checkbox"/>	<input type="checkbox"/>	<input type="checkbox"/>	<input type="checkbox"/>	<input type="checkbox"/>	<input type="checkbox"/>
Electronic Differential Lock (EDL)		<input type="checkbox"/>	<input type="checkbox"/>	<input type="checkbox"/>	<input type="checkbox"/>	<input type="checkbox"/>	<input type="checkbox"/>
Electronic Stabilisation Control (ESC)		<input type="checkbox"/>	<input type="checkbox"/>	<input type="checkbox"/>	<input type="checkbox"/>	<input type="checkbox"/>	<input type="checkbox"/>
Sport exhaust system		—	—	<input checked="" type="checkbox"/>	—	—	—
Recuperation		<input type="checkbox"/>	<input type="checkbox"/> ⁶	<input type="checkbox"/>	<input type="checkbox"/>	<input type="checkbox"/> ⁶	<input type="checkbox"/>
Start-stop system		<input type="checkbox"/>	<input type="checkbox"/> ⁶	<input type="checkbox"/>	<input type="checkbox"/>	<input type="checkbox"/> ⁶	<input type="checkbox"/>
Audi cylinder on demand		<input type="checkbox"/> ⁷	—	<input type="checkbox"/>	<input type="checkbox"/> ⁷	—	<input type="checkbox"/>
Audi TDI clean diesel		<input type="checkbox"/> ⁸	—	—	<input type="checkbox"/> ⁸	—	—
Misfuelling protection		<input type="checkbox"/> ⁸	—	—	<input type="checkbox"/> ⁸	—	—
Airbags		<input type="checkbox"/>	<input type="checkbox"/>	<input type="checkbox"/>	<input type="checkbox"/>	<input type="checkbox"/>	<input type="checkbox"/>
Side impact protection		<input type="checkbox"/>	<input type="checkbox"/>	<input type="checkbox"/>	<input type="checkbox"/>	<input type="checkbox"/>	<input type="checkbox"/>
Integrated head restraint system		<input type="checkbox"/>	<input type="checkbox"/>	<input type="checkbox"/>	<input type="checkbox"/>	<input type="checkbox"/>	<input type="checkbox"/>

¹ Not available in conjunction with A8 hybrid luggage set. ² The trailer towing hitch for retrofitting is available from Audi Genuine Accessories. ³ Standard for 4.2 TDI quattro. ⁴ Only available for 8-cylinder models.

⁵ Standard for 4.0 TFSI quattro. ⁶ Hybrid technology. ⁷ Only available for 4.0 TFSI quattro. ⁸ Only available for diesel models.

	Page	A8	A8 hybrid	S8	A8 L	A8 L hybrid	A8 L W12
Technology/safety (continued)	93						
Deactivation switch for front-passenger airbag		■	■	■	■	■	■
Seat belts		□	□	□	□	□	□
Audi exclusive seat belts		■	■	■	■	■	■
ISOFIX child seat mounting and top tether for the outer rear seats		□	□	□	□	□	□
First-aid kit		□	□	□	□	□	□
Warning triangle		□	□	□	□	□	□
Warning and control lights		□	□	□	□	□	□
Audi Extended Warranty	93						
Audi Extended Warranty		■	■	■	■	■	■

Equipment for the Audi A8 illustrated (p. 4–13):

Paint finish: floret silver, metallic

Wheels: cast aluminium wheels in 10-spoke star design

Seat upholstery: Valcona leather, Atlas beige

Inlays: upper inlay in poplar, brown silver;

lower inlay in high-gloss black; extended aluminium look in the interior

Equipment for the Audi A8 L illustrated (p. 14–17):

Paint finish: Oolong grey, metallic

Wheels: forged aluminium wheels in 10-parallel-spoke design, partly polished*

Seat upholstery: unicum leather, nutmeg

Inlays: upper inlay in walnut, dark brown;

lower inlay in brushed aluminium, silver

Equipment for the Audi A8 L W12 illustrated (p. 18–23):

Paint finish: phantom black, pearl effect

Wheels: forged aluminium wheels in 15-spoke structured design, high-gloss polished finish*

Seat upholstery: Valcona leather, velvet beige

Inlays: upper inlay in fine grain ash, natural gold brown;

lower inlay in brushed aluminium, silver; extended aluminium look in the interior

Equipment for the Audi S8 illustrated (p. 24–31):

Paint finish: Daytona grey, pearl effect

Wheels: cast aluminium wheels in 5-triple-spoke design (S design)

Seat upholstery: Valcona leather, Vermont brown/granite grey (Audi design selection)

Inlays: upper inlay in carbon red;

lower inlay in brushed aluminium, silver; extended aluminium look in the interior;

headlining and rear parcel shelf in Alcantara, black

□ Standard equipment ■ Optional equipment — Not available

Country-specific variations possible. Please find out from your local Audi partner which equipment is standard and what optional equipment is available in your country.

More detailed descriptions of a selection of items from the equipment range can be found from page 52 onwards.

*Please note the special information relating to wheels on page 99.

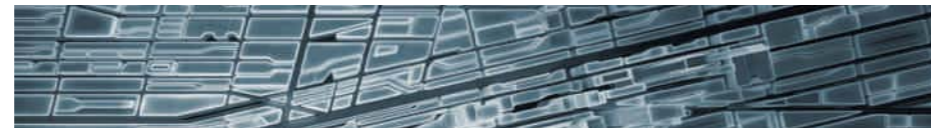

Responsibility

Living up to our responsibilities is a principle that is firmly anchored in Audi strategy. Alongside commercial success and international competitiveness, our responsibility toward company employees and society as a whole is a key consideration, as is protecting the environment and conserving resources. And what is true in the details – our catalogues are printed on FSC-certified paper – also holds in general: Audi develops cars that are not only sporty and emotive but also ever more efficient. In the long run, Audi wants its products

to allow CO₂-neutral mobility. Seeing to it that production in Audi plants gradually becomes CO₂-neutral is another aspect of our comprehensive approach. Audi is also committed to society – particularly in the fields of education, technology and social projects. At Audi, sustainability is closely linked with how we see the future: the Audi Urban Future Initiative sees Audi working with international experts to get to the root of future urban challenges and trends in mobility.

Discover the world of Audi.



The Audi experience

The fascination of Audi can be experienced in many different ways. Audi City in London, for example, gives you digital access to all models at their actual size and in real time. And of course it is always worth visiting one of the major motor shows. This is where Audi always presents its new models and invites you to take a look at how the future is being shaped with “Vorsprung durch Technik”. Anyone interested in seeing how Audi is already putting this into practice will find fascinating insight in the “Vorsprung durch Technik” online special at www.audi.com. But a look back can also be rewarding: at the Audi museum mobile in Ingolstadt, history and high-tech go hand in hand. A total of 130 historic exhibits and state-of-the-art



forms of presentation make for a thrilling symbiosis. Plus, Audi driving experience allows you to live the excitement and countless possibilities of current Audi models. Here, pure driving enjoyment is combined with valuable learning effects. This is ensured by a team of specially trained and highly qualified instructors who provide practical tips to help you optimise your driving skills. All this can now also be enjoyed at the recently opened Audi driving experience center in Neuburg, near Ingolstadt. Facilities here include a circuit of up to 3.4 kilometres that features challenging combinations of bends, a 30,000 m² dynamic driving area and an offroad section where Q models can be put through their paces.



Team spirit

Motorsport is a driving force behind the brand. For years Audi has been among the champions in various racing series, for instance the 24 Hours of Le Mans or the DTM German Touring Car Masters. The values that are crucial in many different areas of sport are also central ones for Audi: precision, passion and technology. No coincidence then that Audi has been sponsoring sporting events for

many years. In the world of winter sports, for example, Audi has been the main sponsor of the German Ski Association (DSV) for almost three decades and has also partnered 14 other national alpine teams. In football, we support national and international teams. And Audi is also a partner for the German Olympic Sports Confederation.

Choosing an Audi means choosing a brand that offers more. More individuality. More exclusivity. More fascination.

www.audi.com

Information on all the topics mentioned above can be found on our website: www.audi.com.



www.audi.com



configurator.audi.com



www.audi.com/vorsprung-durch-technik



www.audi.com/driving



www.audi.com/cr

Equipment Audi A8/A8 L/A8 L W12/S8

230/115/100V socket	86	Audi sound system	88
360 degree cameras	91	Audi Space Frame (ASF®) body	93
A8 Audi exclusive concept	66, 67	Audi TDI clean diesel	93
A8 hybrid luggage set	87	Auxiliary heating/ventilation	84
Active Noise Cancellation	93	Bang & Olufsen Advanced Sound System	88
adaptive air suspension	92	Bluetooth interface	90
adaptive air suspension – sport	55, 92	Bose Surround Sound	88
Adaptive brake light	106	Brake callipers, painted black	55
adaptive cruise control with Stop&Go function including Audi pre sense front	91	Brake system	109
Additional reading lights in the rear	81	Bumper, front	55
Airbags	109	Camera-based speed limit display	92
Aluminium-look interior	78	Centre armrests	105
Ambient lighting	80	Ceramic brake	92
Anti-Slip Regulation (ASR)	109	Cigarette lighter and ashtray	86
Anti-theft alarm	85	Comfort centre armrest, front	76
Anti-theft wheel bolts	104	Comfort head restraints, rear	76
Antilock Brake System (ABS) with Electronic Brake Force Distribution (EBD)	109	Convenience key with sensor-controlled release of the luggage compartment lid	85
Assistance package including Audi pre sense plus	92	Cruise control	90
Attention assist	108	Cup holders	108
Audi active lane assist	91	Dark-tinted windows (privacy glazing)	84
Audi connect including car phone	89	Deactivation switch for front-passenger airbag	110
Audi cylinder on demand	93	Deluxe automatic air conditioning systems	84
Audi design selection Balao brown	61	Diffuser insert, rear	55
Audi design selection sycamore grey	60	Digital Audio Broadcasting	88
Audi design selection Vermont brown	55, 58, 59	Digital TV reception	88
Audi drive select	92	Door sill trims	55, 81
Audi exclusive	62-65	Double/acoustic glazing	84
Audi exclusive bar compartment	86	Driver information system with colour display	87
Audi exclusive cardan reading lights in rear	81	DVD/CD changer	88
Audi exclusive carpet and floor mats	81	Dynamic steering	55, 92
Audi exclusive coolbox	86	Electric steering wheel adjustment	107
Audi exclusive foldaway table	87	Electromechanical parking brake	109
Audi exclusive leather controls	83	Electromechanical power steering	92
Audi exclusive leather upholstery and trim	74	Electronic Differential Lock (EDL)	109
Audi exclusive parcel shelf in Alcantara	76	Electronic Stabilisation Control (ESC)	109
Audi exclusive seat belts	93	Engine start/stop button, S-specific	55
Audi exclusive storage compartment	86	Exhaust tailpipes	55, 106
Audi Extended Warranty	93	Extended aluminium-look interior	78
Audi Genuine Accessories	94, 95	Exterior mirror housings in aluminium look	55
Audi Matrix LED headlights	80	Exterior mirrors	107
Audi music interface	88	First-aid kit	110
Audi phone box	90	Floor mats	81, 106
Audi pre sense basic	90	Footrests, rear	76
Audi side assist including Audi pre sense rear	91	Front-wheel drive	109
Audi Singleframe	55, 106	Garage door opener (HomeLink)	85

Equipment Audi A8/A8 L/A8 L W12/S8

Grab handles with wooden segments	78	Powermeter in the instrument cluster	87
Handset in the front and rear for car phone	90	Preparation for mobile phone (Bluetooth)	90
Handset in the front for car phone	90	Preparation for tracking system	108
Head-up display	91	Provision for trailer towing hitch	108
Headlinings	76, 105	quattro®	92
Heat-insulating glass	107	quattro® with sport differential	55, 92
Hold assist	109	Rear Seat Entertainment	89
Inlays	55, 78, 79	Rear seat packages	76, 77
Instrument cluster, S-specific	55	Rear seat system	77
Insulating/acoustic glass	84	Recuperation	109
Integrated head restraint system	109	Remote control key	85
Interior and exterior lighting package	80	Reversing camera	90
Interior mirror, automatically dimming	107	Run-flat tyres	104
Ioniser	85	S8-specific analogue clock with grey dial	55
ISOFIX child seat mounting and top tether for the outer rear seats	93	Seat belts	110
Leather packages	74	Seat heating systems	76
LED headlights	80	Seat upholstery	55, 74, 75
LED rear lights	80	Seat ventilation systems	76
LED rear lights with dynamic indicators	80	Seats	55, 72, 73
Light/rain sensor	106	Secondary collision brake assist	92
Luggage compartment lid, automatically opening	108	Selector levers	55, 82, 107
Luggage compartment lid, electrically opening and closing	85	Side impact protection	109
Luggage compartment package	87	Side sill trims	55
Massage functions	76	Slide-and-tilt glass sunroof	83
Memory function for standard seats, front	76	Solar slide-and-tilt sunroof	83
Misfuelling protection	109	Spare wheel, space-saving	104
MMI®	87	Sport exhaust system	55
MMI® navigation plus with MMI touch	87	Start-stop system	93
MMI® radio plus	88	Steering wheel rims with wooden segments	83
MMI® touch	87	Steering wheels	55, 82, 83
Mobile phone holder in the rear	109	Storage compartments	108
Model name/logo	55	Sunblinds	84
Navigation data (hard drive)	108	Through-loading facility	85
Night vision assistant	91	Through-loading facility with removable ski/snowboard bag	85
Non-smoker package	86	tiptronic	92
Paint finishes	55, 68, 69	Trailer towing hitch	87
Panoramic glass sunroof	83	Tyre pressure loss indicator	104
Park assist with display of surroundings	90	Tyre repair kit	104
Parking system plus	90	Vanity mirrors and additional reading lights in the rear	81
Pedals and footrest in stainless steel	55	Vehicle jack	104
Personalisation of the Audi exclusive foldaway table	87	Vehicle tool kit	104
Power-assisted closing for the luggage compartment lid	108	Warning and control lights	110
Power-assisted door closing	85	Warning triangle	110
		Wheels/tyres	55, 70, 71
		Xenon plus	80



AUDI AG
85045 Ingolstadt
www.audi.com
Valid from September 2014

Printed in Germany
433/1230.82.18

The models and equipment versions illustrated and described in this brochure and some of the services listed are not available in all countries. Some of the cars illustrated are equipped with optional features for which an extra charge is made. Details concerning the delivery specifications, appearance, performance, dimensions and weights, fuel consumption and running costs of the vehicle were correct to the best of our knowledge at the time of going to press. Deviations from the colours and shapes shown in the illustrations may occur. No liability is accepted for errors and printing errors. The right to introduce modifications is reserved. Not to be reproduced, including in part, without the written approval of AUDI AG.

This brochure is printed on paper made from pulp bleached without the use of chlorine.

